

WiFi Smart  
UV Clothes Drying Rack

ADR-383-SC



Online Warranty Registration



Please read these instructions and warranty information carefully before use and keep them handy for future reference.

## USER MANUAL

請即進行保用登記！  
有關保用條款細則，請看說明書最後一頁。

---

Please register your warranty information now !  
For Warranty Terms & Conditions,  
please refer to the last page of this user manual.

# Table of Contents

---

Warnings & Safety Precautions 04

Product Structure 07

Installation Instructions 08

Operation Instructions 09

Cleaning & Maintenance 19

Troubleshooting 20

Technical Specification 21

Warranty Terms & Conditions 39

# Warnings & Safety Precautions

---

## **WARNING!**

Read all instructions carefully before using this product.

- This product is for domestic indoor use only. If this product is used for any commercial, industrial, rental or other purposes, product warranty will be VOIDED.
- This product is not intended for use by children or persons with reduced physical, sensory or mental capabilities, or lack of experience and knowledge, unless they have been given supervision or instruction concerning use of this product by an adult responsible for their safety.
- Mind your children and DO NOT let children play with this product.
- Cleaning and user maintenance shall not be made by children without supervision.
- Check the voltage indicated on the rating label before using this product.
- If the supply cord is damaged, it must be replaced by the manufacturer, its service agent or similarly qualified persons in order to avoid hazards.
- Unplug this product from the power source before cleaning and maintenance.
- Contact German Pool authorized service technician for repair or maintenance of this product.

## **Important Safety Instructions**

1. All instructions must be strictly adhered to. Improper installation may lead to serious accidents and injury.
2. This product must be installed by professional technicians from German Pool Customer Service & Repair Centre.
3. DO NOT use this product during thunderstorms.
4. To ensure the proper installation and use of this product, it must be installed on a solid reinforced concrete ceiling and at a height of 2.3 meters or higher.
5. DO NOT install this product in a humid environment, such as areas prone to leaks, seepage, or direct exposure to water.

## **Indoor Use Environment**

1. This product is for use in indoor use in buildings only. The surrounding air must be free of flammables, corrosive gases and conductive dust. DO NOT expose this product to rain.
2. This product is only for use in an environment with temperature between -15 °C to 43 °C, with a maximum relative humidity of 90% (at an ambient temperature of 25 °C).
3. Power source: rated voltage  $\pm 1\%$ , rated frequency  $\pm 1\text{Hz}$ .
4. When installing this product, make sure the installation surface is free from any components that may affect the normal operation of this product.
5. This product has Heat Dry function, DO NOT install this product near curtains or other flammable items to avoid the risk of fire.
6. To prevent harm to children, the installation of this product must ensure that the lowest heating element is at least 1200mm above the ground.
7. When installing this product, make sure this product is disconnected from the power source when connecting the wiring. DO NOT connect the power source before confirming this product has been safely connected.

# Warnings & Safety Precautions

---

## Other Safety Instructions

1. The fixed wiring connected to this product must be installed according to wiring regulations, with a full-pole switch device that has a contact separation distance of no less than 3mm.
2. If the power cable is damaged, to avoid danger, it must be replaced by professional technicians from German Pool Customer Service & Repair Centre.
3. This product must be properly grounded. DO NOT use this product without reliable grounding, and DO NOT connect the ground wire to the neutral wire.
4. DO NOT disassemble this product by yourself. Repair must be performed by professional technicians from German Pool Customer Service & Repair Centre.
5. DO NOT expose the remote control to moisture or impact, as it may affect the lifespan of the remote control.
6. The effective range of the remote control may vary depending on the usage environment, so please choose an appropriate location for operation.
7. When the remote control malfunctions or its sensitivity significantly decreases, it is necessary to promptly replace the batteries. If the remote control will not be used for an extended period of time, please remove the batteries.
8. The Heat Dry function of this product is only for drying washed fabrics.
9. DO NOT connect this product in series or in parallel with any other electrical appliances.
10. When using this product, DO NOT exceed its rated loading weight.
11. During normal use, make sure that there are no obstructions in the lifting direction of this product.
12. DO NOT let children play with this product and the remote control. Keep the remote control out of reach of children.
13. DO NOT use this product for other purposes.
14. When this product is raising or lowering, DO NOT insert hands into the pole holder and the structure of the telescopic rack (scissor frame) to prevent personal injury.
15. The correct way to hang clothes must be followed, meaning clothes should be evenly distributed on both sides of the hanging pole. DO NOT hang clothes on only one side to prevent the hanging pole from tilting.
16. Exercise caution around the operating machinery; DO NOT stand underneath this product while it is in operation.
17. When Disinfect function is activated, keep at least 2m away from this product, and DO NOT look directly at the UV light or expose your skin to the UV light.
18. This product has Heat Dry function. DO NOT install it close to curtains or other flammable substances to avoid the risk of fire.
19. Users must adhere to the instructions in the manual or quick guide when using this product. Users shall bear all responsibility for any damage or loss resulting from improper use of this product.
20. This product is strictly prohibited from continuous high-intensity operation. Within the rated load, the "one-on, five-off" principle should be implemented to ensure the stability of the motor; which implies the machine should be stopped for at least 5 minutes per each 1-minute usage before running for another 1 minute, and so on.

# Warnings & Safety Precautions

---

## Battery Safety Precautions

1. When changing the batteries in the remote control, DO NOT touch any of the buttons, otherwise it may cause temporary malfunction of the remote control. If buttons are accidentally triggered, remove the batteries from the remote control and let it sit for about 1 minute before correctly reinstalling the batteries, and normal functionality will be automatically restored.
2. DO NOT use rechargeable batteries with this product's remote control. Only batteries approved by the manufacturer are permitted. Replacing batteries with an incorrect model may compromise the remote control's safety protection system, leading to explosion, fire or other dangers.
3. DO NOT expose the batteries to a high temperature environment, such as direct sunlight, fire, microwave oven, oven, etc., otherwise it may lead to explosion or leakage of flammable fluid and gas.
4. DO NOT dismantle, impact, squeeze or cut the batteries, as it may result in an explosion.
5. DO NOT expose the batteries to extreme low-pressure environments, as it may lead to battery explosion or leakage of flammable fluid and gas.
6. If the batteries show severe swelling, DO NOT use and immediately replace them.
7. DO NOT swallow the batteries as it may cause severe chemical burns.
8. If you suspect a battery has been swallowed or inserted into any part of the body, seek emergency medical attention immediately.
9. If the battery compartment cannot be securely closed, stop using the remote control immediately and keep it out of children's reach.
10. Keep new and old batteries out of the reach of children at all times.
11. DO NOT dispose of batteries in household waste. User must comply with local regulations regarding the safe disposal of used batteries.

## WARNING!

- This product is equipped with a UV lamp. DO NOT stare directly at the UV light source.
- DO NOT look at the UV light from any angle to avoid causing permanent damage to the eyes.
- DO NOT shine the UV light on bare skin, and DO NOT expose your skin to the UV light.
- When UV Button is pressed, UV disinfection will activate immediately! DO NOT stand below or near this product when pressing the UV Button!
- Stand away from this product before pressing the UV Button; if this product is installed on the balcony ceiling, close the curtains before pressing the UV Button to activate UV Disinfection Function; if this product is installed in a room, leave the room and shut the door before pressing the UV Button to activate UV Disinfection Function.

# Product Structure

## Main Body

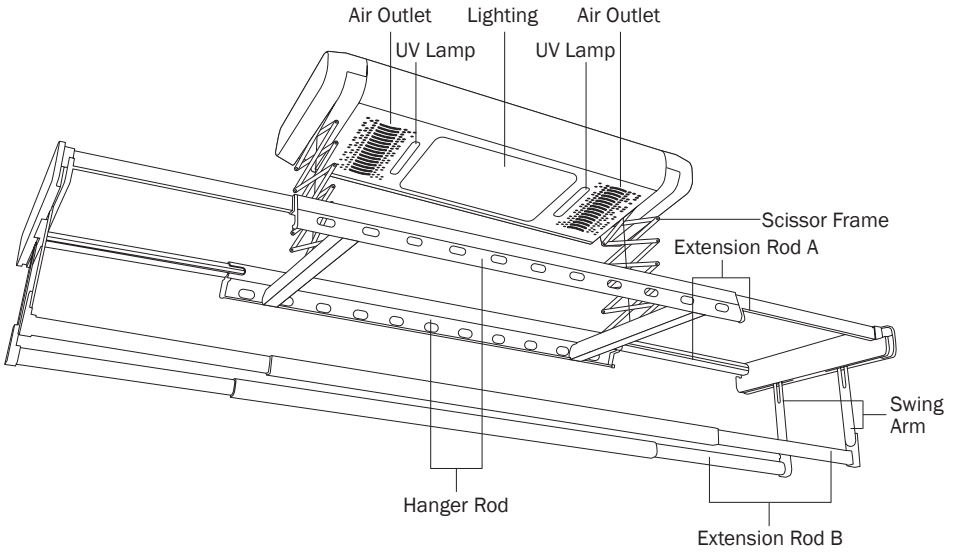

Please check for the following parts in the packing box:



Hanger Rods For Small Clothes\*4



Paper Template Guide



Remote Control

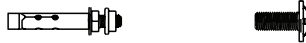

Screws (Expansion Anchor\*4, M4\*6 Bolt with Washer\*4)

### Note:

Please make sure the above parts are ready before installation. Missing any of these parts may affect installation.

# Installation Instructions

## Installing The Expansion Anchors

1. Measure the ceiling installation location and mark the spots for the expansion anchors. If this product will replace your ceiling lamp, make sure to disconnect the power source of the ceiling lamp beforehand.
2. Tape the paper template guide to the ceiling, then drill four  $\text{Ø}10 \times 80\text{mm}$  holes as marked on the template.
3. Install the expansion anchors into the drilled holes and tighten the screws. On one end, loosen the 2 lower bolts of the expansion anchors so that there is a 5mm gap between the upper and lower bolts; on the other end, take the 2 lower bolts off completely.

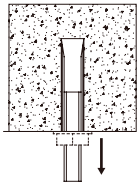

Take off 2 lower bolts on one end

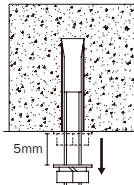
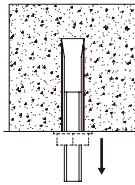

Loosen 2 lower bolts 5mm on the other end

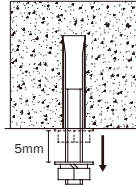

## Installing The Main Unit

1. Remove the left and right end covers of the product, and insert one end of the main unit's frame plate into the 5mm space of the expansion anchors (between the upper and lower bolts), then tighten up the lower bolts to secure this side of the frame plate.

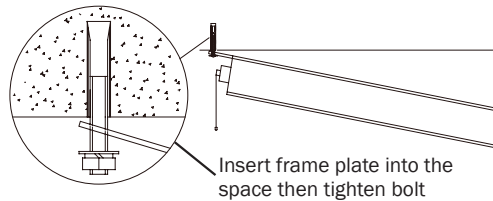

Insert frame plate into the space then tighten bolt

2. Fit the other side of the main unit frame plate over the other 2 expansion anchors (the ones with the lower bolts removed), then screw on the lower bolts so that the whole frame plate is securely installed.



3. Connect the wires correctly: Brown to live wire, blue to neutral wire, yellow-green to ground wire, then wrap the wires with insulating tape and lay them into the gap between the main unit and the ceiling.





# Operation Instructions

## ⚠ WARNING!

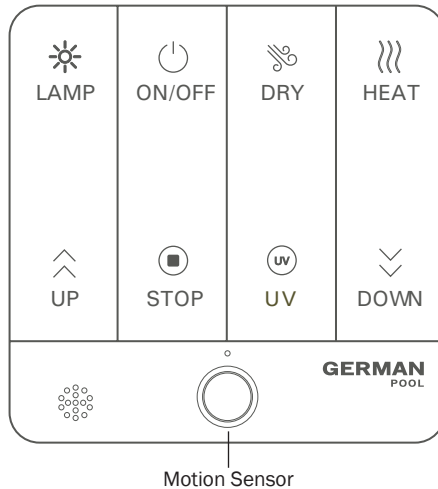
- This product is equipped with a UV lamp. DO NOT stare directly at the UV light source.
- DO NOT look at the UV light from any angle to avoid causing permanent damage to the eyes.
- DO NOT shine the UV light on bare skin, and DO NOT expose your skin to the UV light.
- Remote Control is equipped with a motion sensor, it is recommended that the remote control be installed next to the door of the room or balcony.



## NOTE:

In any mode, when On/Off Button  is pressed, product will turn off immediately. Pressing On/Off Button  again will not turn the product back on. To turn the product back on, press your desired mode button.

## Automatic Motion Sensor

This product is equipped with a motion sensor which will automatically turn the product on and off when motion is detected.

1. Automatically turn off UV Lamp: When UV Disinfection Lamp is turned on, and motion is detected near the remote control, the UV lamp will automatically turn off and disinfection process will terminate.
2. Automatically turn on lighting: When power is connected, and motion is detected near the remote control, the lighting will automatically turn on; when lighting is turned on, if motion sensor does not detect any motion, the lighting will automatically turn off.

# Operation Instructions



## NOTE:









Automatic Lighting Function only activates when the surroundings are dark. In a brightly lit environment, it will not automatically turn the lighting on or off.

To manually deactivate or reactivate Automatic Lighting Function, please follow these steps:

- To use the lamp as room lighting, press LAMP button twice continuously on the remote control, and the lamp will light up indefinitely; to turn off the lamp, press LAMP button again.
- UV lamp cannot be turned on indefinitely.

## How To Pair The Remote Control

If the product does not respond to the remote control, please pair them again: Disconnect the power source to the Clothes Drying Rack, wait 1 minute then reconnect the power. Place the remote control beneath the clothes drying rack, and simultaneously long-press Up  and Stop  buttons until the clothes drying rack beeps twice to signal pairing is successful.

Button		Function
 LAMP	Lighting Lamp	<ul style="list-style-type: none"> <li>Press this button to turn on the lamp (with Automatic Motion Sensor), press again to turn off the lamp</li> <li>Press this button twice continuously to turn on the lamp indefinitely, press again to turn off the lamp</li> </ul>
 UP	Up	<ul style="list-style-type: none"> <li>Press this button to raise the hanger rod</li> <li>Hanger rod will automatically stop when it is completely raised up</li> </ul>
 ON/OFF	On/Off	In any mode, press this button to turn off the product
 STOP	Stop	Press this button to stop the hanger rod from rising or lowering
 DRY	Air Dry	<ul style="list-style-type: none"> <li>Press this button to turn on or turn off Air Dry Function</li> <li>Maximum drying time is 2 hours. Air Dry Function will automatically turn off after 2 hours</li> </ul>
 UV	Disinfect	<ul style="list-style-type: none"> <li>Press this button to turn on or turn off UV Disinfection Function</li> <li>Maximum UV disinfecting time is 30 minutes. UV Disinfection Function will automatically turn off after 30 minutes</li> </ul> <p><b>⚠ WARNING!</b> When this button is pressed, UV Disinfection will activate immediately! DO NOT stand below or near this product when pressing the UV Button!</p> <p><b>⚠ WARNING!</b> Stand away from this product before pressing the UV Button; if this product is installed on the balcony ceiling, close the curtains before pressing the UV Button to activate UV Disinfection Function; if this product is installed in a room, leave the room and shut the door before pressing the UV Button to activate UV Disinfection Function.</p>
 HEAT	Heat Dry	<ul style="list-style-type: none"> <li>Press this button to turn on or turn off Heat Dry Function; when Heat Dry Function is turned on, Air Dry Function will automatically turn on simultaneously</li> <li>Maximum drying time is 2 hours. Heat Dry Function will automatically turn off after 2 hours, and Air Dry Function will automatically turn off as well</li> <li>When Heat Dry Function is turned off, the fan will run for an extra time to dissipate residual heat</li> </ul>
 DOWN	Down	<ul style="list-style-type: none"> <li>Press this button to lower the hanger rod.</li> <li>Hanger rod will automatically stop when it has lowered down completely</li> </ul>



# Operation Instructions

---





## NOTE:

When the loading capacity of the hanger rod reaches the limit of 45kg and the UP button  is pressed, the product will continue to sound a buzzer.

## Setting Hanger Rod's Descent Height

1. Press DOWN button  and allow the hanger rod lower to your desired height.
2. Press STOP button  to stop hanger rod at your desired height.
3. Long-press LAMP button  for 5 seconds until the buzzer beeps twice, setting is confirmed. Next time you press DOWN button, the hanger rod will automatically lower to your preset height.





## Setting Hanger Rod's Ascent Height

1. Press UP button  and allow the hanger rod to rise to your desired height.
2. Press STOP button  to stop hanger rod at your desired height.
3. Long-press LAMP button  for 5 seconds until the buzzer beeps twice, setting is confirmed. Next time you press UP button , the hanger rod will automatically raise to your preset height.





## Note:

The set ascending height must exceed half of the factory default distance. eg. if the full descent distance is 120cm, the descent height must be set below 60cm, while the ascent height must be set above 60cm.





## Reset to Factory Default Descent Height

1. Press DOWN button , hanger rod lowers to your set height.
2. Press DOWN button  again, and the hanger rod will continue to lower to the lowest height.
3. Long-press LAMP button  for 5 seconds until the buzzer beeps twice, setting is confirmed. Next time you press DOWN button , the hanger rod will lower to the factory default maximum distance.

## Reset to Factory Default Ascent Height

1. Press UP button , hanger rod rises to your set height.
2. Long-press UP button  for 5 seconds, and the hanger rod will continue to rise to the highest height.
3. Long-press LAMP button  for 5 seconds until the buzzer beeps twice, setting is confirmed. Next time you press UP button , the hanger rod will rise to the factory default maximum height.

## Adjust the Volume of the Buzzer

1. Long-press DOWN button  and LAMP button  until the buzzer beeps twice, the volume of the buzzer will decrease.
1. Long-press DOWN button  and LAMP button  again until the buzzer beeps twice, the volume of the buzzer will return to normal.

# Operation Instructions

## Connecting The Product To WiFi

This product can be controlled via smartphone with German Pool Smart Control APP.

### Note:

To connect the product to WiFi, please use WiFi with a frequency of 2.4 GHz, does not work with WiFi with a frequency of 5.0 GHz.

## A. How To Set Up The APP

1. Connect your phone to 2.4 GHz WiFi then scan the QR Code below, or search "German Pool Smart Control" in App Store or Google Play to download and install the APP.



Apple IOS System  
App Store



Android System  
Google Play

## B. Change The Language

### Apple IOS System

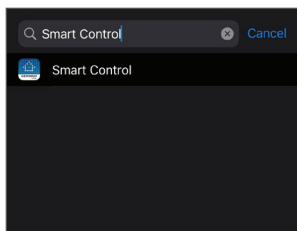

1. Search "Smart Control" in Settings.

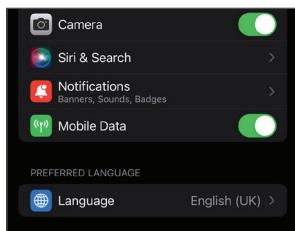

2. Click "Preferred Language".

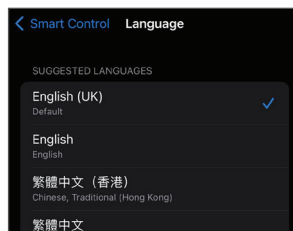

3. Select Traditional Chinese or English in the "Suggested Languages" column (Note: if user select "Traditional Chinese (Hong Kong)", app will display in English).

### Android System

App will appear in your preset phone language. If you need to change APP language, you need to change the system language in your phone settings.

# Operation Instructions

## C. Register Your Account

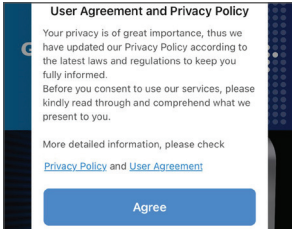

1. Open the APP , click “Agree” on “User Agreement and Privacy Policy”.

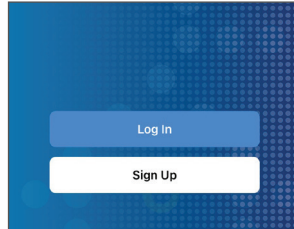

2. Click “Sign Up” to register your account.

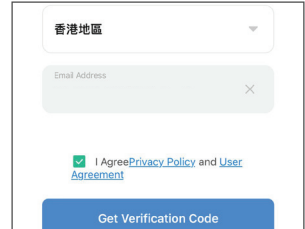

3. Enter your email address, tick “I agree Privacy Policy and User Agreement”, then click “Get Verification Code”.

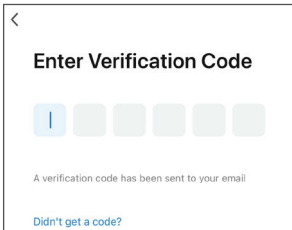

4. Enter one-time verification code from your email.

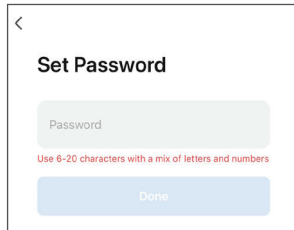

5. Set up your password then click “Done”.

# Operation Instructions

## D. Pairing Sequence

### Auto Pairing



1. Long-press the product's Up Key and Stop Key for 5 seconds until buzzer beep 4 time.

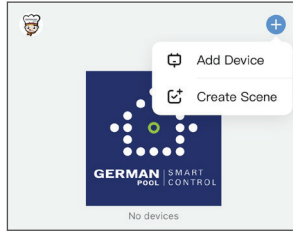

2. Click “+” on the upper right corner of the APP homepage, then click “Add Device”.

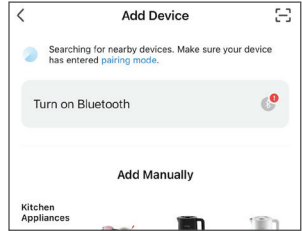

3. Before pairing, user must allow the App to access your Bluetooth. Tap on “Turn on Bluetooth” (if Bluetooth is already on, ignore this step).

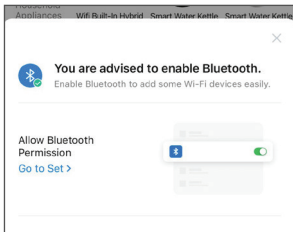

4. Tap “Go To Set” (if Bluetooth is already on, ignore this step).

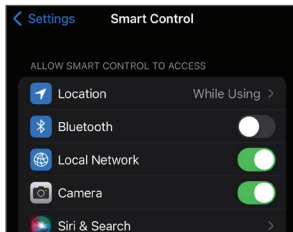

5. Turn on Bluetooth (if Bluetooth is already on, ignore this step).

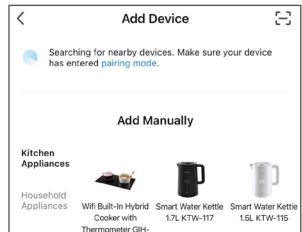

6. APP will show “Searching for nearby devices...”.

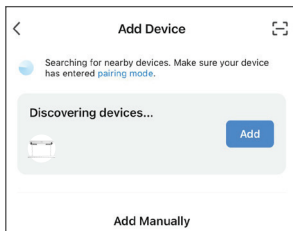

7. APP will show “Discovering devices...”, click “Add”.

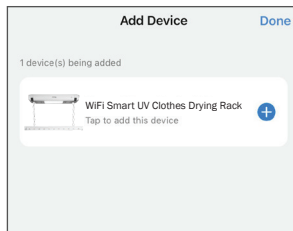

8. Click “+” on the right of product name.

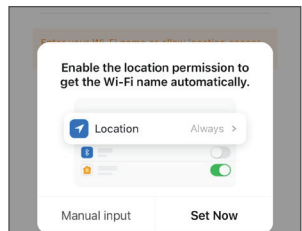

9. it is recommended to allow the APP to access your location. Tap “Set Now” (if Location is already on, ignore this step).

# Operation Instructions

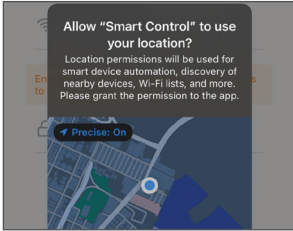

10. Tap “Allow While Using App” (if Location is already on, ignore this step).

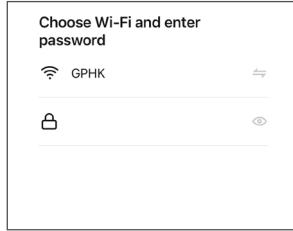

11. Select WiFi name and enter your WiFi password, then click “Next”.

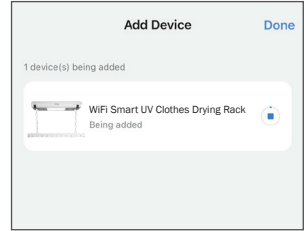

12. APP will show “Being Added”, the product and APP will automatically pair up.

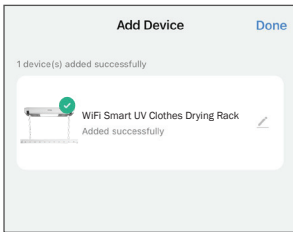

13. When pairing is completed, APP will show “Added successfully”. Click “Done” to return to homepage.

## ⚠ WARNING!

If Bluetooth is turned off or App is not permitted to access Bluetooth, the product cannot be paired. (Note: Even if Bluetooth is turned on, it does not mean the APP is allowed to access your Bluetooth.)

## Note:

- The product can only be paired to one account at a time. If another user pairs their smartphone to the product, the previous account will lose their control of the product.
- User who has already been paired can share their control rights with other users. For details, see “E. Sharing Control”.

## Note:

If APP cannot find the product, or during Pairing Sequence, if APP shows an exclamation mark icon, it means pairing is unsuccessful. Please use method 2 below for pairing.

# Operation Instructions

## E. Sharing Control



1. On the product's homepage, click “✎” on the upper right corner.

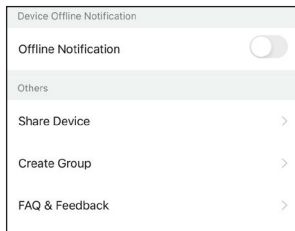

2. Click “Share Device” under “Others”.

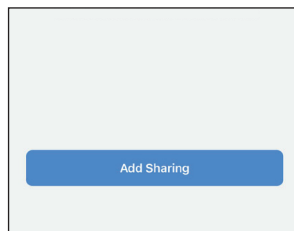

3. Click “Add Sharing”.

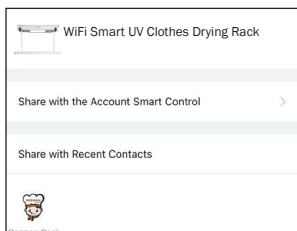

4. Set the number of users with whom you wish to share control, then click “Share with the Account Smart Control”.

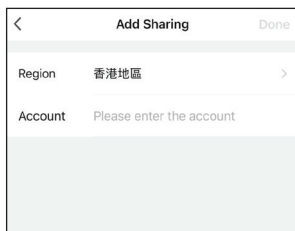

5. Enter that account's registered email address, then click “Done” on the upper right corner.

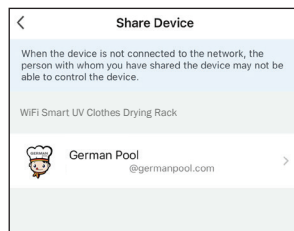

6. Repeat step 3-5 to share with more accounts.

### Note:

On the “Share Device” page, you can add or delete other accounts' control rights.



# Operation Instructions

## Controlling The Product With The APP

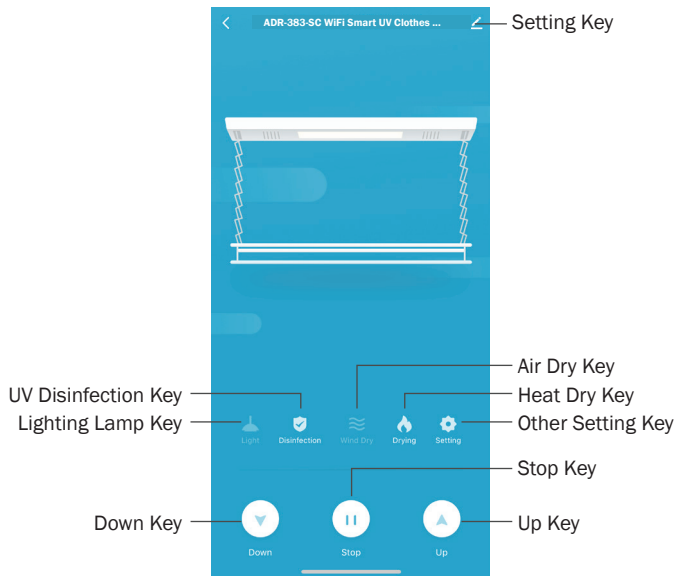

# Operation Instructions

Button	Function
UV Disinfection Key	<ul style="list-style-type: none"> <li>Press this button to turn on or turn off UV Disinfection Function</li> <li>Maximum UV disinfecting time is 30 minutes. UV Disinfection Function will automatically turn off after 30 minutes</li> </ul> <p>⚠ <b>WARNING!</b> When this button is pressed, UV Disinfection will activate immediately! DO NOT stand below or near this product when pressing the UV Button!</p> <p>⚠ <b>WARNING!</b> Stand away from this product before pressing the UV Button; if this product is installed on the balcony ceiling, close the curtains before pressing the UV Button to activate UV Disinfection Function; if this product is installed in a room, leave the room and shut the door before pressing the UV Button to activate UV Disinfection Function.</p>
Lighting Lamp Key	Press this button to turn on the lamp, press again to turn off the lamp
Air Dry Key	<ul style="list-style-type: none"> <li>Press this button to turn on or turn off Air Dry Function</li> <li>Maximum drying time is 2 hours. Air Dry Function will automatically turn off after 2 hours</li> </ul>
Heat Dry Key	<ul style="list-style-type: none"> <li>Press this button to turn on or turn off Heat Dry Function; when Heat Dry Function is turned on, Air Dry Function will automatically turn on simultaneously</li> <li>Maximum drying time is 2 hours. Heat Dry Function will automatically turn off after 2 hours, and Air Dry Function will automatically turn off as well</li> <li>When Heat Dry Function is turned off, the fan will run for an extra time to dissipate residual heat</li> </ul>
Other Setting Key	
Down Key	<ul style="list-style-type: none"> <li>Press this button to lower the hanger rod</li> <li>Hanger rod will automatically stop when it has lowered down completely</li> </ul>
Stop Key	Press this button to stop the hanger rod from rising or lowering
Up Key	<ul style="list-style-type: none"> <li>Press this button to raise the hanger rod</li> <li>Hanger rod will automatically stop when it is completely raised up</li> </ul>

# Cleaning & Maintenance

---

## **WARNING!**

- Turn off the product and disconnect the power source before cleaning and maintenance.
  - DO NOT scrub this product with scourer pad or other hard items.
  - DO NOT use rough abrasives or metal scrapers to clean this product.
1. Disconnect the power source of this product, and use a wrung out soft cloth to wipe the surface of the main unit and hanger rods, then dry off with a dry cloth.
  2. Regularly clean off dust and grease on the scissor frame. After cleaning, user can add a suitable amount of lubricating oil or peanut oil on the scissor frame to ensure smooth elevation; when cleaning or maintaining other parts, user must first disconnect the power source.
  3. To ensure smooth elevation of the product, regularly wipe the steel cable with a dry cloth to clean off any dust accumulation.
  4. If any abnormality occurs during use, immediately disconnect the product's power source and contact German Pool Customer Service & Repair Centre.
  5. Regularly inspect all movable components of this product. If abnormal wear is detected, it must be replaced by professional technicians from German Pool Customer Service & Repair Centre.

# Troubleshooting

Problem	Possible Cause	Solution
Remote control does not respond	Main unit is not connected to power	Connect power
	Remote control's indicator lights blink or do not light up	Properly reinstall or change batteries; batteries may be leaking fluid, open the remote control lid and clean inside
	Remote control is not paired to the main unit	Repeat pairing sequence
UV disinfecting lamp does not light up	UV lamp has blown out	Replace UV lamp
Hanging rod emits abnormal noise during use	There are burrs on the steel cables' guide wheels	Grind the burrs on the guide wheels or iron pin shafts
	Foreign object on the scissor frame's slide rail	Clean the slide rail
Hanging rod does not ascend or descend	Resistance during descent	Remove blockage underneath the hanger rod
	Overload protection	Partially unload clothing on hanger rod
	Resistance during ascent	Remove blockage above the hanger rod or retract the extension rod
	Motor cable, 6P cable or 4P cable are loosened	Contact German Pool Customer Service & Repair Centre
	Hanger rod's load is not balanced	Balance out the clothing
Lighting lamp does not light up	Main unit's power is not connected	Connect power
	Lighting lamp has blown out	Replace lighting lamp
	Lighting lamp connection is loose	Reconnect the lighting lamp
Failure to connect to phone APP	Wrong WiFi password	Check to see WiFi password is correct
	WiFi signal too weak	Place router closer to this product
	User is using 5G WiFi network	Use 2.4G WiFi network

## **WARNING!**

If problem persists, please contact German Pool Customer Service & Repair Centre for assistance. DO NOT disassemble this product by yourself.

# Technical Specification

---

<b>Model</b>	<b>ADR-383-SC</b>
Power	839 W
Voltage	220-230 V~
Frequency	50 Hz
Product Dimensions	Retracted : (H) 105±10 mm (W) 957±10mm (D) 467±5mm
	Extended : (H) 1520±10mm (W) 1650±10mm (D) 467±5mm
Net Weight	11.1 ± 0.1 kg
Maximum Load	45 kg
WiFi Frequency	2.4 GHz

- Specification is subject to change without prior notice.
- If there is any inconsistency or ambiguity between the English version and the Chinese version, the English version shall prevail.
- Refer to [www.germanpool.com](http://www.germanpool.com) for the most update version of the user manual.

請即進行保用登記！  
有關保用條款細則，請看說明書最後一頁。

---

Please register your warranty information now !  
For Warranty Terms & Conditions,  
please refer to the last page of this user manual.

# 目錄

---

警告及注意事項 24

產品結構 26

安裝說明 27

使用說明 28

清潔及保養 37

故障檢修 37

技術規格 38

保用條款 39

# 警告及注意事項

## ⚠ 警告！

使用本產品前，請仔細閱讀所有說明。

- 本產品只限家居室內日常使用，如產品作任何商業、工業、出租或其他用途，保用證即告失效。
- 請勿讓兒童或身體有殘障、精神不健全及對本產品缺乏經驗或知識的人士單獨使用本產品；如需使用，必須要在負責任的成年人監管下方可使用。
- 應照顧好兒童，確保他們不會玩耍本產品。
- 無成年人監管下，勿讓兒童清潔及維護本產品。
- 使用前，請先檢查所有電壓是否與本產品標籤上的電壓相符。
- 如果電源線損壞，為免發生意外，電源線必須由廠方、廠方指定的維修中心或同等合格的技術人員進行更換。
- 清潔或檢查本產品前，必須先關機及拔掉插頭。
- 請聯繫德國寶授權的技術人員進行維修或保養本產品。

## 重要安全說明

1. 必須遵守所有說明，錯誤安裝會導致嚴重傷人事故。
2. 本產品必須由德國寶客戶服務及維修中心的專業人員進行安裝。
3. 雷雨天氣時，嚴禁使用本產品。
4. 為確保產品正常安裝使用，必須選擇實心鋼筋混凝土天花板，且安裝高度在2.3m以上。
5. 嚴禁將本產品安裝在潮濕環境中，如漏水、滲水、兩淋等。

## 建築物室內使用環境

1. 本產品僅限建築物室內環境使用，周圍空氣中必須無易燃、腐蝕性氣體及導電塵埃，且嚴禁暴露在雨水中使用。
2. 使用環境溫度在 $-15^{\circ}\text{C}$ – $43^{\circ}\text{C}$ ，最大相對濕度90%（當環境溫度在 $25^{\circ}\text{C}$ 時）。
3. 電源：額定電壓 $\pm 1\%$ ，額定頻率 $\pm 1\text{Hz}$ 。
4. 安裝本產品時，必須確認安裝表面無其他影響本產品正常運行的部件。
5. 本產品帶有烘乾功能，嚴禁靠近窗簾和其他可燃產品附近安裝，以免導致火災隱患。
6. 為避免對兒童造成傷害，本產品的安裝必須使得最低的加熱元件距離地面至少1200mm。
7. 安裝本產品時，必須確保本產品在斷電的情況下連接電源線，在確認安全接通的情況下方可通電試機。

## 其他安全說明

1. 本產品連接的固定佈線必須按照佈線規則安裝一個觸點間距不小於3mm的全極開關裝置。
2. 如電源線損壞，為避免危險，必須德國寶客戶服務及維修中心的專業人員更換。
3. 本產品必須正確連接地線，嚴禁在無可靠接地情況下使用，嚴禁將地線接在零線上。
4. 嚴禁私自拆卸本產品，需要進行維修時，必須由德國寶客戶服務及維修中心的維修人員維修。
5. 嚴禁使遙控器受潮或受到撞擊，否則會影響遙控器使用壽命。
6. 遙控器的有效距離受使用環境影響會有所差異，請選擇適當位置。
7. 遙控器失靈或靈敏度明顯下降時，必須及時更換電池。長時間不使用遙控器時，請將電池卸載。



# 警告及注意事項

8. 本產品的烘乾功能，僅用於乾燥水洗的紡織物。
9. 本產品嚴禁與其他任何電器產品串聯或並聯。
10. 使用本產品時承重嚴禁超過額定承重。
11. 正常使用時，必須確保本產品升降方向無其他物品阻礙。
12. 嚴禁讓兒童玩耍本產品及遙控器，將遙控器放在遠離兒童的地方。
13. 嚴禁將本產品用作其他用途。
14. 在本產品升降運行過程，嚴禁將手伸入晾衣杆杆座和伸縮架（剪刀架）結構內，以免造成人身傷害。
15. 必須採用正確晾曬衣物方式，即兩側晾衣杆必須均勻懸掛晾曬衣物，嚴禁單邊或單側晾曬，以免晾衣杆發生傾斜。
16. 小心運行中的機器，在本產品運行時，下方嚴禁站人。
17. 開啟消毒功能時，必須與本產品保持至少2m距離，避免眼睛直視或暴露皮膚。
18. 本產品帶有烘乾功能，安裝時嚴禁靠近窗簾或其他可燃材料，以免發生火災。
19. 必須依照說明書或快速指南指示使用本產品，如因使用不當造成任何損失，由用戶自行承擔。
20. 本產品嚴禁連續高強度不間斷工作。在額定承重內，應實施「開一停五」的原則。則運行1分鐘，需要停機最少5分鐘以上，方可再運行1分鐘，如此類推，以保證摩打穩定性。

## 電池注意事項

1. 更換遙控器電池時，嚴禁觸碰按鍵區域，否則可能導致遙控器短暫工作異常，如不慎誤碰，請將遙控器扣出電池靜置約1分鐘，再重新正確安裝電池即可自動恢復正常功能。
2. 本產品遙控器嚴禁使用充電電池，僅允許使用製造商認可的電池。使用錯誤型號的電池更換可能使安全防護失效，會有爆炸、火災等危險。
3. 嚴禁將電池放置於極高溫度的環境中，如日照、投入火中、微波爐、烤箱等，可能會導致爆炸或洩漏可燃液體或氣體。
4. 嚴禁拆解、撞擊、擠壓或切割電池，可能導致爆炸。
5. 嚴禁將電池置於極低氣壓，可能導致電池爆炸或洩漏可燃液體和氣體。
6. 若電池出現嚴重膨脹，嚴禁繼續使用。
7. 嚴禁吞咽電池，可能導致化學灼傷危險。
8. 如您認為電池可能已被吞食或放置在身體的任何部位內，必須立即尋求醫療救助。
9. 如電池槽未能安全閉合，必須停止使用該產品並使之遠離兒童。
10. 必須讓兒童遠離新的和使用過的電池。
11. 嚴禁將電池扔進生活垃圾進行處理，必須遵守所在地區相應的規定安全處置用完的電池。

## ⚠ 警告！

- 本產品配備紫外線燈，嚴禁凝視紫外線光源。
- 嚴禁任何角度望紫外線，以免對眼睛造成永久性損害。
- 嚴禁將紫外線照射皮膚，或讓皮膚暴露在紫外線之中。
- 當按下「消毒鍵」鍵後，UV消毒燈會立即開啟！嚴禁在產品下方或附近按「消毒鍵」！
- 按「消毒鍵」前必須遠離本產品；如產品安裝在露台，必須先拉上窗簾再按此鍵使用UV消毒功能；如產品安裝在房間內，必須先離開該房間並關上門後再按此鍵使用UV消毒功能。

# 產品結構

## 主機

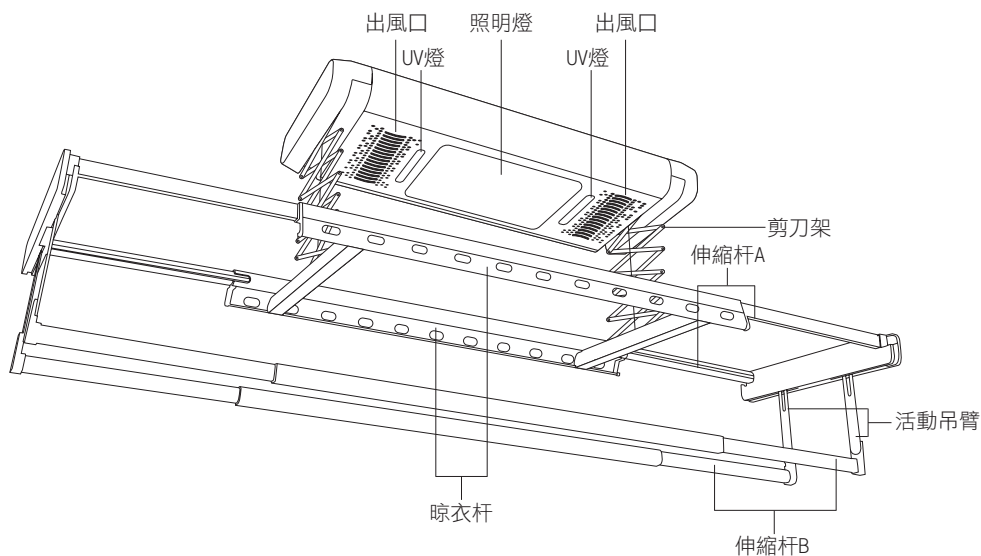

請檢查包裝箱內包含以下配件：



小衣物掛杆\*4



安裝模板



遙控

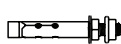

螺絲配件 (膨脹螺絲\*4、M4\*6帶墊螺絲\*4)

### 注意：

請確保以上配件齊備，以免影響安裝。

# 安裝說明

## 打膨脹螺絲

1. 測量天花板安裝位置的尺寸，確定安裝位置並作好記號。如果本產品將會代替原有的露台燈，先切斷露台燈的電源。
2. 將安裝模板黏貼在天花板上，然後按模板上的指示打出4個 $\text{Ø}10 \times 80$ 毫米的孔。
3. 將膨脹螺絲打入天花板後擰緊螺絲，將一邊的2粒螺絲下端的外螺母鬆開，使上螺母和外螺母之間的距離為約5mm；另一邊的2粒螺絲取下下端的外螺母。

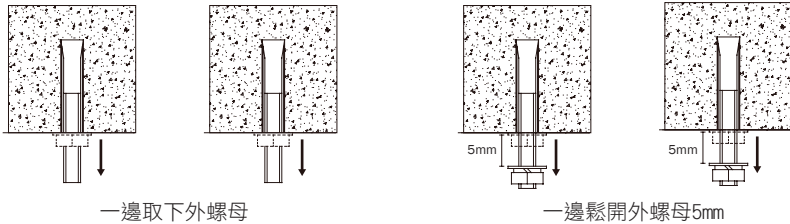

## 安裝主機

1. 拆下主機左右兩邊的裝飾外蓋，將主機一邊的螺絲卡槽插在膨脹螺絲的上螺母和外螺母之間的5mm的空間，然後擰緊外螺母，固定這一邊的主機框架。

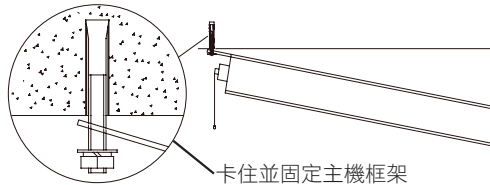

2. 主機另一邊的螺絲卡槽對準已拆下外螺母的膨脹螺絲裝上，然後裝回外螺母並擰緊，固定整個主機框架。

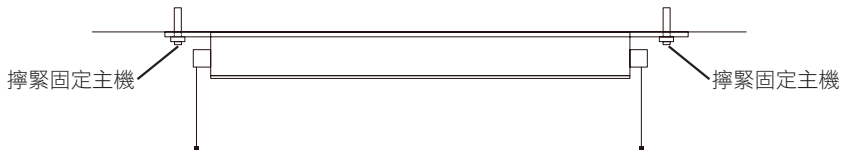

3. 正確連接好電線：棕色接火線，藍色接零線，黃綠雙色接地線，然後用絕緣膠包好放進主機與天花板的縫隙裡。

# 使用說明

## ⚠ 警告！

- 本產品配備紫外線燈，嚴禁凝視紫外線光源。
- 嚴禁任何角度望紫外線，以免對眼睛造成永久性損害。
- 嚴禁將紫外線照射皮膚，或讓皮膚暴露在紫外線之中。
- 由於遙控器配備動態感應器，建議將遙控器安裝在出入口位置，例如房間門邊或露台門邊。

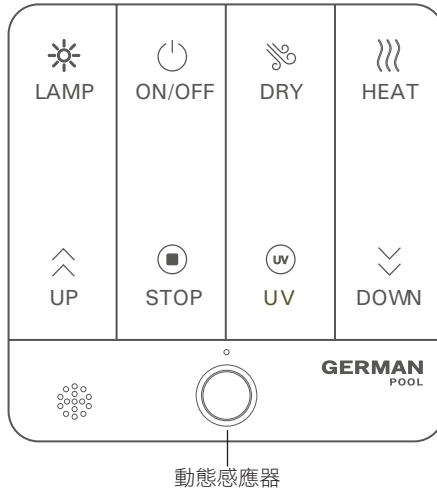

## 注意：

在任何模式下按「開關鍵 ⏻」關機後，如再按「開關鍵 ⏻」將不會開機（再按「開關鍵 ⏻」無反應）。如需開機，請按所需模式的按鍵。

## 動態感應功能

本產品的遙控器配備動態感應器，透過感應人體活動達至自動開關功能。

1. 自動關閉UV消毒燈：在啟動UV消毒燈後，如在消毒過程中檢測到人體移動（當人體靠近遙控器時），產品將自動關閉UV消毒燈，中止消毒。
2. 自動開關照明燈：在產品通電後如檢測到人體移動（當人體靠近遙控器時），產品將自動開啟照明燈；在照明燈亮著後，如檢測不到人體移動，產品將自動關閉照明燈。









## 注意：

- 「自動開關照明燈功能」只在環境幽暗的情況下啟動，如照明充足，將不會自動開啟或關閉照明燈。
- 如需長期開啟照明燈，連續按「照明鍵 ☀」2次，照明燈將會長亮；如需關閉照明燈，按「照明鍵 ☀」1次。
- UV消毒燈無法長期開啟。

# 使用說明

## 遙控器對碼方法

如使用遙控器時產品無反應，請將遙控器重新對碼：切斷乾衣架電源，等待1分鐘後重新開電源；然後將遙控器置於乾衣架下方，同時按「上升鍵 $\wedge$ 」和「停止鍵 $\odot$ 」直至聽到乾衣架發出蜂鳴器聲響兩聲，表示對碼成功。





按鍵		說明
 LAMP	照明鍵	<ul style="list-style-type: none"><li>按此鍵開啟照明燈（動態感應功能），再按1次關閉照明燈</li><li>連續按此鍵2次長期開啟照明燈，再按1次關閉照明燈</li></ul>
 UP	上升鍵	<ul style="list-style-type: none"><li>按此鍵後晾衣杆上升</li><li>直至晾衣杆完全回收後自動停止</li></ul>
 ON/OFF	開關鍵	在任何模式下，按此鍵關機
 STOP	停止鍵	當晾衣杆上升或下降期間按此鍵，晾衣杆停止移動
 DRY	風乾鍵	<ul style="list-style-type: none"><li>按此鍵開啟或關閉風乾功能</li><li>每次使用風乾功能的最長運行時間為2小時，2小時後自動關閉</li></ul>
 UV	消毒鍵	<ul style="list-style-type: none"><li>按此鍵開啟或關閉UV消毒功能</li><li>每次使用UV消毒功能的最長運行時間為30分鐘，30分鐘後自動關閉</li></ul> <p><b>⚠ 警告！</b>當按下此鍵後，UV消毒燈會立即開啟！嚴禁在產品下方或附近按此鍵！</p> <p><b>⚠ 警告！</b>按此鍵前必須遠離本產品；如產品安裝在露台，必須先拉上窗簾再按此鍵使用UV消毒功能；如產品安裝在房間內，必須先離開該房間並關上門後再按此鍵使用UV消毒功能。</p>
 HEAT	烘乾鍵	<ul style="list-style-type: none"><li>按此鍵開啟或關閉烘乾功能；開啟烘乾功能後，風乾功能自動同步開啟</li><li>每次使用烘乾功能的最長運行時間為2小時，2小時後自動關閉，風乾功能亦自動同步關閉</li><li>關閉烘乾功能後，風扇會延時關閉進行散熱</li></ul>
 DOWN	下降鍵	<ul style="list-style-type: none"><li>按此鍵後晾衣杆向下伸出。</li><li>直至晾衣杆完全伸出後自動停止</li></ul>

### 注意：





當晾衣杆的承重達到上限45kg，按「上升鍵 $\wedge$ 」時，產品會持續發出蜂鳴器提示聲。

# 使用說明

## 設定晾衣杆下降幅度

1. 按「下降鍵」，待晾衣杆下降到合適的高度。
2. 按「停止鍵」，確認晾衣杆停在合適的高度。
3. 長按「照明鍵」5秒直至蜂鳴器發出提示聲2聲，設置完成；下次再按「下降鍵」時，晾衣杆自動停在所設定的高度。





## 設定晾衣杆上升幅度

1. 按「上升鍵」，待晾衣杆上升到合適的高度。
2. 按「停止鍵」，確認晾衣杆停在合適的高度。
3. 長按「照明鍵」5秒直至蜂鳴器發出提示聲2聲，設置完成；下次再按「上升鍵」時，晾衣杆自動停在所設定的高度。





### 注意：

設定的上升幅度或下降幅度必須超過出廠時完整行程的一半，例如下降的完整行程為120cm，必須在60cm以下設置下降幅度；而上升幅度則必須設定在60cm以上。





## 回復出廠時的下降幅度

1. 按「下降鍵」，晾衣杆下降至所設定的高度。
2. 再按1次「下降鍵」，晾衣杆繼續下降到最低位置。
3. 長按「照明鍵」5秒直至蜂鳴器發出提示聲2聲，設置完成下次再按「下降鍵」時，晾衣杆回復出廠時的下降幅度。

## 回復出廠時的上升幅度

1. 按「上升鍵」，晾衣杆上升至所設定的高度。
2. 長按「上升鍵」5秒直至晾衣杆繼續上升到最高位置。
3. 長按「照明鍵」5秒直至蜂鳴器發出提示聲2聲，設置完成下次再按「上升鍵」時，晾衣杆回復出廠時的上升幅度。

## 調整蜂鳴器提示聲響亮度

1. 長按「下降鍵」及「照明鍵」直至蜂鳴器發出提示聲2聲，蜂鳴器提示聲的響亮度將會變細。
2. 再次長按「下降鍵」及「照明鍵」直至蜂鳴器發出提示聲2聲，蜂鳴器提示聲的響亮度回復正常。

# 使用說明

## 使用WiFi連接本產品

本產品可透過德國寶智能控制應用程式「German Pool Smart Control」APP以智能手機操控。

### 注意：

必須使用頻率為2.4 GHz的WiFi進行連接，不適用於頻率為5.0 GHz的WiFi。

## A. 下載應用程式

連接頻率為2.4 GHz的WiFi後，掃描下方二維碼，或於蘋果iOS系統上的App Store或安卓Android系統上的 Google Play搜尋「German Pool Smart Control」，下載並安裝APP。



蘋果iOS系統  
App Store



安卓Android系統  
Google Play

## B. 設置APP語言

### 蘋果iOS系統

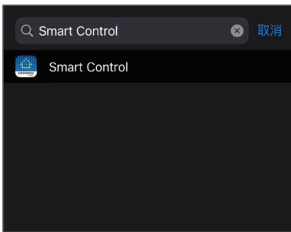

1. 在手機的設定中搜尋「Smart Control」。



2. 點擊「偏好的語言」。

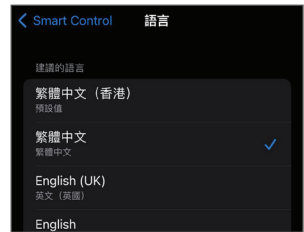

3. 在「建議的語言」一欄中選擇繁體中文或英文（注意：選擇「繁體中文(香港)」APP將會顯示英文）。

### 安卓Android系統

預設為系統所使用的語言，如需更改APP語言，需在設置中更改系統語言。

# 使用說明

## C. 註冊用戶資料

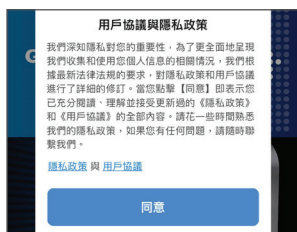

1. 打開APP，點擊「用戶協議與隱私政策」上的「同意」。
2. 點擊「註冊」註冊用戶資料。
3. 輸入電郵地址，別選「我同意隱私政策與用戶協議」後點擊「獲取驗證碼」。



4. 輸入電郵裡的驗證碼。
5. 設定您的登入密碼後點擊「完成」，完成註冊。



# 使用說明

## D. 配對本產品

### 自動配對



1. 長按遙控器上的「上升鍵」及「停止鍵」5秒，直至蜂鳴器發出提示聲4聲。



2. 點擊APP主頁右上角「+」，再點擊「添加設備」。



3. 配對前必須先打開藍牙權限，點擊「打開藍牙」（如已打開，可忽略此步驟）。



4. 點擊「去設定」（如已打開，可忽略此步驟）。

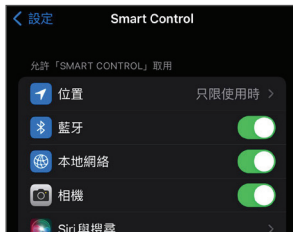

5. 點擊藍牙一欄以打開藍牙權限（如已打開，可忽略此步驟）。

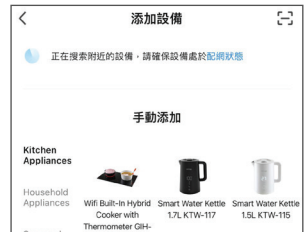

6. APP顯示「正在搜索附近的設備...」。



7. 數秒後APP顯示「發現設備...」，點擊「添加」。



8. 點擊產品名稱右方的「+」。



9. 配對時建議開啟位置權限，點擊「立即設置」（如已開啟，可忽略此步驟）。

# 使用說明



10. 點擊「使用App時允許」（如已開啟，可忽略此步驟）。



11. 輸入手機所連接的WiFi名稱及密碼，點擊「下一步」。



12. APP顯示「正在添加」，產品與APP自動配對中。



13. 配對完成後APP顯示「添加成功」，按右上角「完成」進入產品主界面。

## ⚠ 警告！

如沒有開啟藍牙或沒有打開藍牙權限，將無法配對產品；注意，即使電話已開啟藍牙功能，並不代表已打開「藍牙權限」。

## 注意：

- 每次只可以一個帳戶進行配對，如由另一帳戶再次進行配對，先前已配對的帳號將失去本產品的操作權。
- 已配對的帳戶可以分享本產品的操作權予其他帳戶，詳見「E. 操作權分享」部份。

## 注意：

如無法搜索到本產品，或在配對期間APP顯示感嘆號符號，代表配對失敗，請使用下列的方法2進行配對。

# 使用說明

## E. 操作權分享



1. 在本產品操作主界面點擊右上  
角「」。



2. 在「其他」一欄中點擊「共  
用設備」。



3. 點擊下方「添加共用」。

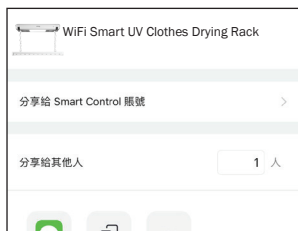

4. 在「分享給其他人」一欄  
中可設定所需分享的人數，  
再點擊「分享給  
SmartControl賬號」。



5. 輸入該帳戶的註冊電郵地  
址，再點擊右上角「完成」  
即可。



6. 重複步驟3-5添加更多其他  
帳戶。

### 注意：

在「共用設備」頁面裡，你可隨時添加或移除帳戶的操作權。

# 使用說明

## 使用APP操作

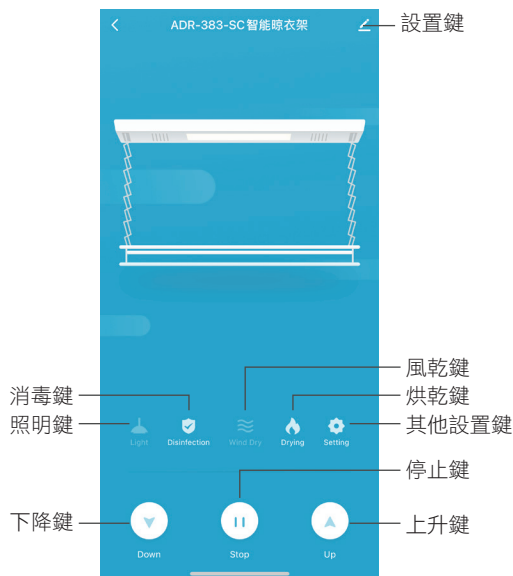

按鍵	說明
消毒鍵	<ul style="list-style-type: none"><li>按此鍵開啟或關閉UV消毒功能</li><li>每次使用UV消毒功能的最長運行時間為30分鐘，30分鐘後自動關閉</li></ul> <p>⚠ 警告！當按下此鍵後，UV消毒燈會立即開啟！嚴禁在產品下方或附近按此鍵！</p> <p>⚠ 警告！按此鍵前必須遠離本產品；如產品安裝在露台，必須先拉上窗簾再按此鍵使用UV消毒功能；如產品安裝在房間內，必須先離開該房間並關上門後再按此鍵使用UV消毒功能。</p>
照明鍵	按此鍵開啟照明燈，再按1次關閉照明燈
風乾鍵	<ul style="list-style-type: none"><li>按此鍵開啟或關閉風乾功能</li><li>每次使用風乾功能的最長運行時間為2小時，2小時後自動關閉</li></ul>
烘乾鍵	<ul style="list-style-type: none"><li>按此鍵開啟或關閉烘乾功能；開啟烘乾功能後，風乾功能自動同步開啟</li><li>每次使用烘乾功能的最長運行時間為2小時，2小時後自動關閉，風乾功能亦自動同步關閉</li><li>關閉烘乾功能後，風扇會延時關閉進行散熱</li></ul>
其他設置鍵	
下降鍵	<ul style="list-style-type: none"><li>按此鍵後晾衣杆向下伸出</li><li>直至晾衣杆完全伸出後自動停止</li></ul>
停止鍵	當晾衣杆上升或下降期間按此鍵，晾衣杆停止移動
上升鍵	<ul style="list-style-type: none"><li>按此鍵後晾衣杆上升</li><li>直至晾衣杆完全回收後自動停止</li></ul>

# 清潔及保養

## ⚠ 警告！

- 維修與保養產品前必須先關機並切斷電源。
- 嚴禁使用鋼絲擦等硬物擦拭本產品。
- 嚴禁使用粗糙擦洗劑或金屬刮刀清潔本產品。

1. 關閉本產品電源，用擰乾的濕軟布擦洗主機和晾衣杆表面，然後再用乾布擦淨。
2. 定期清理晾衣杆托滑軌上的灰塵及油污，清理後可適量添加潤滑油、食用花生油，確保本產品升降運行正常；當清潔或進行其他保養時，必須先切斷電源。
3. 定期清理鋼索上的灰塵，用乾布擦淨，保證本產品升降運行正常。
4. 使用過程中如遇異常情況，必須立即切斷電源並聯絡德國寶客戶服務及維修中心。
5. 定時檢查本產品的活動部件，如果出現磨損異常，必須由德國寶客戶服務及維修中心的專業人員更換。

## 故障檢修

故障現象	可能原因	處理方法
按遙控器後沒反應	主機沒通電	接通電源
	按遙控器指示燈不斷閃爍或不亮	重新正確安裝電池、更換電池；電池可能漏液，拆開清潔
	遙控器與主機未配對	重新配對
UV消毒燈不亮	UV消毒燈燒壞	更換UV消毒燈
晾衣杆運行時發出異響	主機兩側鋼索導輪有批鋒	打磨導輪批鋒或鐵銷軸批鋒
	剪刀架滑軌有異物	清潔滑軌
晾衣杆無法升降	下降遇阻	移除晾衣杆下方的障礙物
	過載保護	卸下晾衣杆上的部份衣物
	上升遇阻	移除晾衣杆上方障礙物或收起伸縮杆
	摩打線、6P線或4P線插頭鬆動	聯絡德國寶客戶服務及維修中心
	晾衣杆掛重不平均	平均晾掛衣物
照明燈不亮	主機沒通電	接通電源
	照明燈損壞	更換照明燈
	照明燈插頭鬆脫	拔除照明燈插頭重新連接
連接手機APP失敗	WiFi密碼錯誤	檢查WiFi密碼是否正確
	WiFi信號太弱	將路由盡量靠近本產品
	使用了5G WiFi網絡	使用2.4G WiFi網絡

## ⚠ 警告！

如無法順利排除故障，請與客戶服務及維修中心聯絡，嚴禁非專業人員對本機拆卸。

# 技術規格

---

<b>型號</b>	<b>ADR-383-SC</b>
功率	839 W
電壓	220-230 V~
頻率	50 Hz
產品尺寸	收納：(H) 105±10 mm (W) 957±10mm (D) 467±5mm
	展開：(H) 1520±10mm (W) 1650±10mm (D) 467±5mm
淨重	11.1 ± 0.1 kg
承重上限	45 kg
WiFi連接頻率	2.4 GHz

- 產品規格及設計如有變更，恕不另行通知。
- 中英文版本如有出入，一概以中文版為準。
- 本產品使用說明書以[www.germanpool.com](http://www.germanpool.com)網上版為最新版本。

# 保用條款

# Warranty Terms & Conditions

此保用提供德國寶產品之機件在正常使用下壹年保用(自購買日起計算)。

Under normal operations, the product will guarantee a 1-year full warranty provided by German Pool (effective from the date of purchase).

\*貴戶須在購機十天內，以下列其中一種方式向本公司登記資料，保用手續方正式生效：

1) 填妥德國寶VIP手機應用程式保用登記表(掃描右方二維碼)

2) 填妥本公司網頁保用登記表  
[www.germanpool.com/warranty](http://www.germanpool.com/warranty)

3) 填妥保用卡郵寄至本公司



\* This warranty is not valid until customer registration information is received by our Service Centre within 10 days of purchase via one of the following means:

1) Visit our VIP App and register online:  
(Scan the QR Code on the right)

2) Visit our website and register online:  
[www.germanpool.com/warranty](http://www.germanpool.com/warranty)

3) Complete the attached Warranty Card and mail it back to our Customer Service Centre.



另請填妥以下表格並與正本發票一併保存，以便維修時核對資料。用戶提供之所有資料必須正確無誤，否則免費保用將會無效。Please fill out the form below. This information and the original purchase invoice will be required for any repairs. Warranty will be invalidated if information provided is found to be inaccurate.

型號 Model No. : ADR-383-SC

機身號碼 Serial No. : \_\_\_\_\_

購買商號 Purchased From : \_\_\_\_\_

發票號碼 Invoice No. : \_\_\_\_\_

購買日期 Purchase Date : \_\_\_\_\_

1. 未能出示購買發票正本者，將不獲免費維修服務。
2. 用戶應依照說明書的指示操作。本保用並不包括：
  - 上門安裝、檢驗、維修或更換零件之人工以及一切運輸費用；
  - 因天然與人為意外造成的損壞(包括運輸及其他)；
  - 電源接合不當、不依說明書而錯誤或疏忽使用本機所引致之損壞。
3. 於下列情況下，用戶之保用資格將被取消：
  - 購買發票有任何非認可之刪改；
  - 產品被用作商業或工業用途；
  - 產品經非認可之技術人員改裝或加裝任何配件；
  - 機身編號被擅自塗改、破壞或刪除。
4. 總代理有權選擇維修或更換配件或其損壞部份。
5. 產品一經被轉讓，其保用即被視作無效。

1. Customer who fails to present original purchase invoice will not be eligible for free warranty service.
2. Customer should always follow the operating instructions. This warranty does not apply to:
  - labour costs for on-site installation, check-up, repair, replacement of parts and other transportation costs;
  - damages caused by accidents of any kind (including material transfer and others);
  - operating failures resulting from applying incorrect voltage, improper usage, and unauthorized installations or repairs.
3. This warranty is invalid if:
  - the purchase invoice is modified by an unauthorized party;
  - the product is used for any commercial or industrial purposes;
  - the product is repaired or modified by unauthorized personnel, or unauthorized parts are installed;
  - the serial number is modified, damaged or removed from the product.
4. German Pool will, at its discretion, repair or replace any defective part.
5. This warranty will be void if there is any transfer of ownership from the original purchaser.

## 客戶服務及維修中心

香港

九龍大業街59號

三湘九龍灣貨運中心地下B室

電話：+852 2773 2888

傳真：+852 2356 9798

電郵：[repairs@germanpool.com](mailto:repairs@germanpool.com)

澳門

澳門青洲大馬路(青洲新路)

515號美居廣場第二期1樓A座

電話：+853 2875 2699

傳真：+853 2875 2661

## Customer Service & Repair Centre

Hong Kong

Unit B, G/F, Sunshine Kowloon Bay

Cargo Centre, 59 Tai Yip Street,

Kowloon, Hong Kong

Tel : +852 2773 2888

Fax : +852 2356 9798

Email : [repairs@germanpool.com](mailto:repairs@germanpool.com)

Macau

A, 1 Andar, Mei Kui Kuong

Cheong Fase 2, No.515 Avenida

Do Conselheiro Borja Macau

Tel : +853 2875 2699

Fax : +853 2875 2661

此保用只適用於香港及澳門

This warranty is valid only in Hong Kong and Macau

## German Pool (Hong Kong) Limited



香港 (S MARK)  
安全認證



中國電器/康電行業  
十大影響力品牌

CEO

CEO非凡品牌大賞



香港優質商號



香港工商業獎



最具昇管  
創建品牌企業獎



香港中小企業  
最佳拍檔大獎



香港消費者  
推銷品牌



香港 (O 導)  
優質服務證書



香港名牌十年成就獎  
HONG KONG TOP BRAND TEN YEAR  
ACHIEVEMENT AWARD

© All rights reserved. Copying, reproducing or using the contents of this manual is not allowed without prior authorization from German Pool, violators will be prosecuted.