

GERMAN
POOL



德國寶

可摺疊式高速電蒸鍋
Foldable Jet Steamer

JET-920

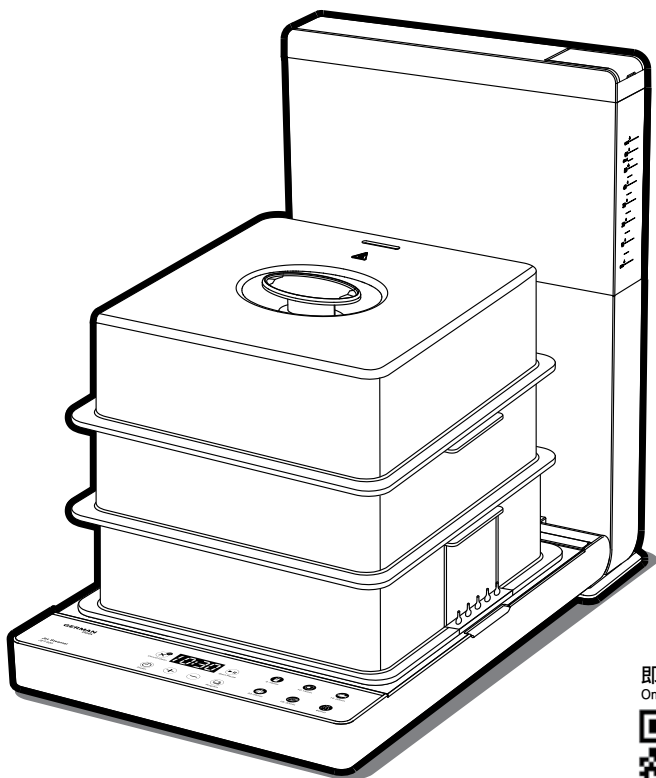

即時網上登記保用
Online Warranty Registration



在使用之前請詳細閱讀「使用說明書」及「保用條款」，並妥為保存。
Please read these instructions and warranty information carefully
before use and keep them handy for future reference.

使用說明書 USER MANUAL

目錄

請即進行保用登記!
有關保用條款細則，請看本說明書最後一頁。

Please register your warranty information now!
For Warranty Terms & Conditions,
please refer to the last page of this user manual.

注意事項	4
產品結構	6
使用說明	7
清潔與保養	10
常見故障及處理	11
技術規格	11
產品線路圖	12
保用條款	23

注意事項

- 為安全起見，初次使用產品前請先細閱本說明書，並保存說明書，以便作參考之用。
- 本產品只供家居使用。請必須依照本說明書內的指示操作。
- 搬動產品時，請以雙手托住產品底部，切勿只提起不銹鋼接水盤、透明水箱、蒸盤或電源線。

警告

1. 將產品連接電源之前，請確保本產品電壓與當地的供電電壓相符合。
2. 本產品只能使用帶接地的電源插座。確保插頭牢固插到電源插座上。
3. 如果使用延長線，延長線必須適合於該設備的電力消耗，否則會導致延長線或插頭過熱。
4. 產品在不使用時和清洗前請將插頭從插座中拔出。
5. 確保電線沒有掛在鋒利的邊緣，並確保遠離高溫物體和明火。
6. 切勿將產品或電源插頭浸在水或其他液體中。容易引起觸電危險！
7. 關閉電源時，請拔下電源插頭，不要拉扯電源線。
8. 如果產品落入水中，請勿觸摸。拔下插頭，關閉產品並將產品送到授權服務中心維修。
9. 不要用濕手拔下或插入插頭。
10. 堅決不要試圖自己打開機器維修，會有電擊風險。
11. 兒童無法識別由於電器操作不當帶來的危害，因此，切勿讓兒童在無成人看管時使用此產品。
12. 切勿在使用過程中無人看管。
13. 本產品不是為商用設計，僅供家用。
14. 不要將本產品用於非指定用途。
15. 本產品不適宜由肢體不健全、感覺或精神上有障礙或缺乏相關經驗和知識的人（包括兒童）使用，除非有負責他們安全的人對他們使用本產品進行監督或指導。照看好兒童，確保他們不玩耍該產品。
16. 如果電源線損壞，為避免危險，必須由製造廠或者其維修部或類似的專職人員來更換。
17. 第一次使用本產品前，請將與食品接觸的部分清洗乾淨後烹飪。
18. 禁止在不穩或者傾斜的檯面使用本產品。
19. 在接通電源前，請確保水箱裡有足夠的水。為了防止溢水，水箱加水時請不要超出水箱中標注的水位標示。

注意事項

20. 小心產品在工作期間從蒸蓋蒸氣孔排出的熱蒸氣或打開蒸蓋時從蒸鍋中冒出的熱蒸氣。手和臉不要靠近機器的熱蒸氣孔和出氣口，以免被蒸氣燙傷。
21. 小心產品在工作期間蒸蓋和接水盤會加熱至高溫，請不要靠近或用手觸摸蒸蓋，以免燙傷。
22. 蒸製過程中或取下蒸蓋時，務必注意蒸鍋中冒出的熱蒸氣，避免燙傷。檢查食物時，一定要使用手柄較長的廚具。
23. 嚴禁在工作過程中移動本產品。
24. 在接水盤冷卻至室溫後，將電源插頭拔掉，才能取出接水盤。
25. 烹飪完成後，請小心地取下蒸蓋，並保持其遠離身體，注意冷凝水，以避免燙傷。
26. 烹調完成後，須待部件冷卻至室溫後才能清洗。
27. 請勿將機器浸入水中或放在水龍頭下沖洗。
28. 請勿將本產品連接至外部計時器，以免發生危險。
29. 如果插頭、電源線、底座或產品本身已經損壞，請不要使用。
30. 請勿過長時間使用本產品(1.0小時以內)，以免接水盤中的液體溢出。如果您需要使用更長時間，請確保將冷凝水每小時一次從接水盤裡倒出。確保在使用過程中沒有液體從接水盤中流出。
31. 請勿頻繁插拔水箱，以免水箱密封圈損壞漏水。
32. 接水盤在使用完成後底部可能有水存留，請擦拭乾淨後再使用。
33. 如發現電器表面有水存留，請立即斷電，待擦乾淨後再使用。
34. 嚴禁乾燒，長期乾燒會影響產品壽命，切勿將產品處於乾燒狀態下超過10分鐘。

警告！

使用過程中，請勿接觸產品表面，因產品運作過程中，表面溫度可能很高。

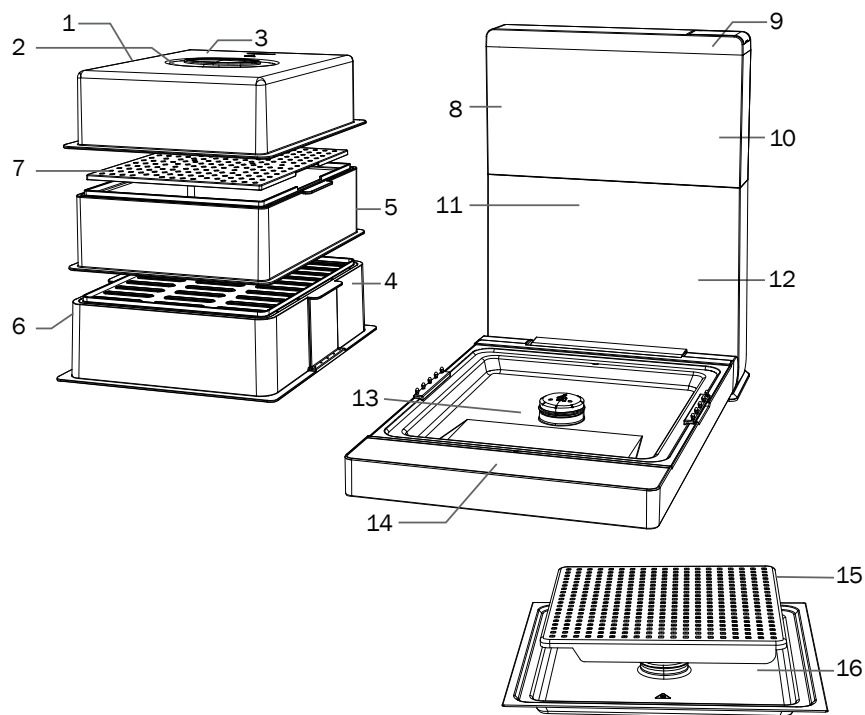

- | | |
|---------|------------|
| 1. 蒸蓋 | 9. 水箱蓋 |
| 2. 蒸蓋提手 | 10. 水位線 |
| 3. 排氣孔 | 11. 指示燈 |
| 4. 蒸格1 | 12. 主機 |
| 5. 蒸格2 | 13. 蒸氣噴射裝置 |
| 6. 蒸板1 | 14. 控制面板 |
| 7. 蒸板2 | 15. 不銹鋼蒸盤 |
| 8. 水箱 | 16. 不銹鋼接水盤 |

使用前

把產品包裝移除，首次使用前請先清潔產品（參考清潔與保養部分）。產品首次使用時可能有煙或者輕微的化學氣味。這是正常的，很快會消失。

步驟1：

取出電蒸鍋，平放在平整檯面上；

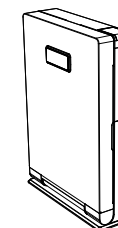

步驟2：

打開電蒸鍋放平在檯面上；裝上蒸盤和接水盤，接水盤在蒸盤的下方；

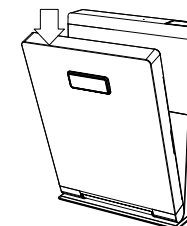

步驟3：

根據所需烹調時間加入相應水量，並放好需要烹飪的食材；

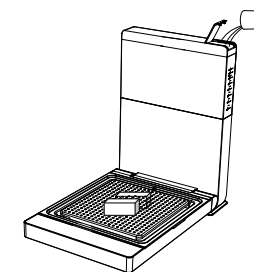

步驟4：



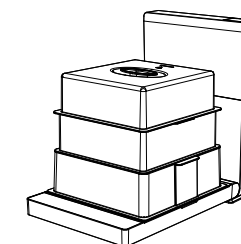







蓋上蒸蓋，插好電源插頭；



使用說明

步驟5：

調整所需烹飪時間

1. 按功能選擇“”按鍵，選擇相應的功能表時間，根據實際需要按“”“”調整相應時間；
2. 每按鍵一次“”1分鐘，長按鍵，時間快速加減調整。按“”開始或者暫停。按“”取消當前烹調模式以重新選擇，再次按此鍵可自動進入清洗功能；
3. 如需預約請選擇相應功能模式後，按“”進入預約功能，根據實際需要按“”“”調整相應時間；每按鍵一次“”1分鐘，長按鍵，時間快速加減調整。



步驟6：

完成烹飪，取出食材，待蒸盤和接水盤冷卻後取出倒掉冷凝水；

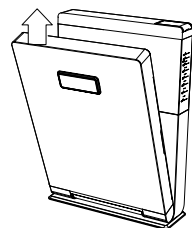
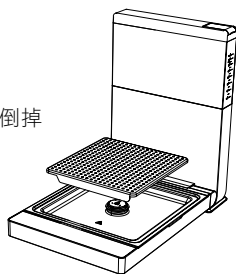

步驟7：

擦乾淨機器後折疊收納好。

使用說明

連續排水

本機特設連續排水功能，可一邊蒸煮，一邊排走冷凝水。

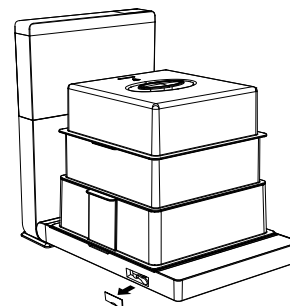

1. 打開機身側面的蓋板。

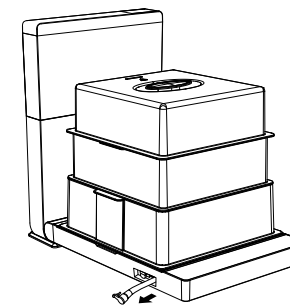

2. 拉出排水軟管。

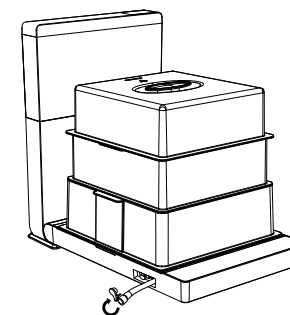

3. 打開排水塞。

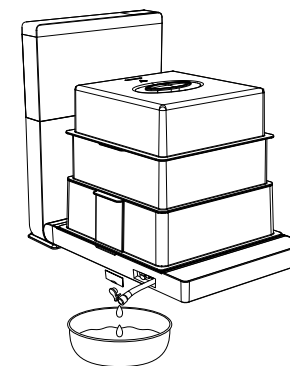

4. 用容器接住軟管一端，進行排水即可。

注意：使用連續排水功能時，須移開不銹鋼蒸盤和接水盤，使用蒸格1做蒸架擺放食物。

清潔與保養

1. 每次使用完成後應該清潔本產品，清潔前，應拔下電源插頭，倒掉接水盤中的冷凝水。
2. 不要使用肥皂、氣油、稀釋劑、酒精、漂白劑、拋光粉、金屬刷、尼龍刷、鋼絲球等清洗產品，否則會損壞產品表面。
3. 請勿將機器浸入水中或放在水龍頭下沖洗。
4. 使用清水清洗蒸板/蒸蓋/蒸格附件，使用柔性乾抹布將本機擦拭乾淨。只有金屬部件可以使用洗碗碟機清洗。
5. 收納前，請確保所有配件乾淨並擦乾。



清除水垢：

產品使用2-3個月（根據實際使用頻率和水质，時間會有差異）後，蒸氣發生器中會有一些水垢沉澱，這是正常現象。沉澱物的多少取決於水質的硬度，因此需要週期性的除垢延長產品使用壽命。（建議使用純淨水）

本機具有自動提示清洗功能，當清洗顯示屏出現“**CL**”標示即本機需要清潔後方可使用。

清潔方法：

1. 往水箱中注入專用除垢劑和水的混合物1500ml，（或者使用1：4體積比的白醋和水的混合物1500ml）（不可使用其它化學物品）；
2. 接通電源；按“**X**”鍵開始清洗；
3. 當清洗完成後，屏幕“**CL**”標示提示會自動消失；
4. 隨後，再往水箱中倒入純淨水再蒸煮10分鐘方可進行烹調。

常見故障及處理

如遇以下一般故障，請按以下指示處理，如仍處理不了或未發現故障原因時，請與本公司維修服務中心聯繫。

注意：為安全著想，再次特別提醒，請勿自行拆卸修理。

問題	可能原因	如何處理
始終沒出蒸氣	1. 是否接通電源 2. 是否插頭鬆動 3. 家中是否有電 4. 水箱中是否有水	1. 插入電源插頭 2. 重新插入電源插頭 3. 接通電源 4. 將水箱中裝滿水
開始沒出蒸氣	· 機器保護延時功能	· 等待約25秒出蒸氣
機器報警出現“滴滴”聲	1. 水箱中無水 2. 水箱有水，管道中空氣未排出造成水位檢測錯誤	1. 將水箱中裝滿水 2. 拔下水箱，直接往進水管道加少量水排出空氣後再插入水箱。
電源燈沒有亮	· 是否接通電源	· 檢查並確保接通電源
機器報警出現“滴滴”聲同時屏幕顯示“ CL ”	· 機器水垢嚴重需要清洗	· 請按「清潔與保養-清除水垢」部份清洗
水箱漏水	· 閥門是否卡入異物	· 清除異物
產品無法吸住折疊	· 高溫下強磁會減弱	· 儘量遠離高溫環境

技術規格

型號	JET-920
電壓	220 - 240 V
頻率	50 Hz
功率	1,500W
折疊尺寸	(H) 430 mm (W) 480 mm (D) 300 mm
淨重	6.7 kg

產品規格及設計如有變更，恕不另行通知。
中英文版本如有出入，一概以中文版為準。
本產品使用說明書以 www.germanpool.com 網上版為最新版本。

產品線路圖

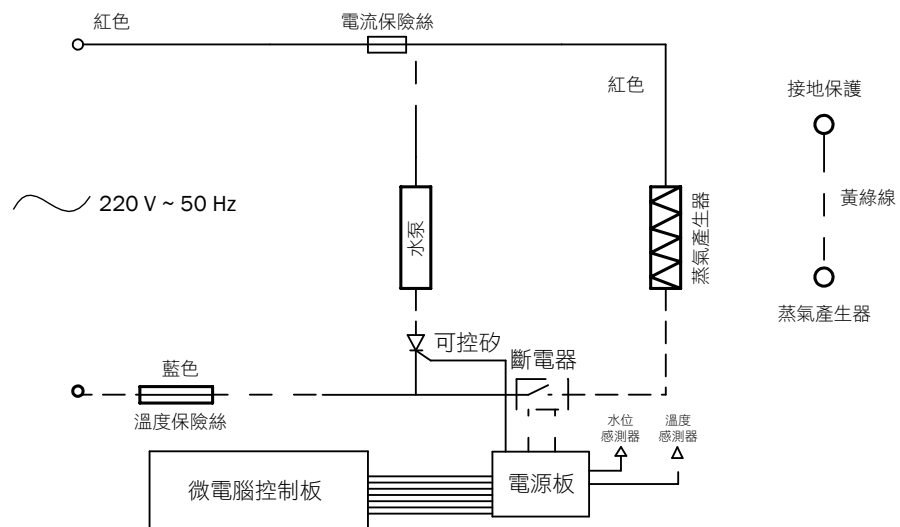

Content

Safety Precautions	14
Product Structure	16
Operating Instructions	17
Care & Maintenance	20
Trouble Shooting	21
Product Specifications	21
Circuit Diagram	22
Warranty Terms & Conditions	23

Safety Precautions

- For safety reasons, read the instructions carefully before using the appliance. Keep the user manual for future reference.
- The appliance is intended for domestic use only. Operate the appliance according to the instructions in this user manual.
- When moving the unit, hold the steamer base with both hands. Do not hold it by the stainless steel drip tray, transparent water tank, steaming plate or power cord alone.

Warning

1. Before activating the appliance, make sure the operating voltage of the appliance matches the local mains voltage.
2. This appliance can only be plugged into a grounded outlet. Make sure it is securely plugged into the socket.
3. Extension cord should meet the electrical requirements of the appliance, otherwise overheating of the extension cord or the plug may occur.
4. Unplug the appliance before cleaning the unit or when it is not in use.
5. Cord should not be hung on sharp edges, and should be kept away from hot substances and flames.
6. Do not immerse the appliance and the plug into water or any other liquid, otherwise it will cause electric shock.
7. Turn off the power before unplugging the appliance. Do not pull the cable to unplug the unit.
8. Never touch the appliance if it drops into water. Unplug it immediately, turn it off and send it to the Customer Service and Repair Centre.
9. Do not plug or unplug the unit with a wet hand.
10. Never attempt any unauthorized repair, or else electric shock may result.
11. Children must not operate any unattended home appliance as they are unable to identify the hazards involved in inappropriate operation.
12. Do not run the appliance unattended.
13. The appliance is not intended for commercial purpose. It is for domestic use only.
14. Do not use the appliance for unintended use.
15. The appliance is not intended for persons (including children) with reduced physical or mental capabilities, or any individual lacking in experience and expertise, unless they are under the supervision of qualified personnel. Keep an eye on children and make sure they do not play with the appliance.
16. To avoid any danger, if power cord is damaged, it must be replaced by the manufacturer, by an authorized repair center or by other qualified technicians.
17. Before using the steamer, thoroughly clean the parts which will be in direct contact with food.

Safety Precautions

18. Do not operate the appliance on a wobbling or tilted work surface.
19. Before activating the appliance, make sure the water tank has enough water. To avoid overflow, water should not exceed the maximum level indicator.
20. Watch out for the hot steam coming from the steam outlet or the surging steam while uncovering the lid. To avoid scald, do not put your hand and face near the steam outlet or air vent.
21. The lid and the drip tray will be hot while the unit is working. To avoid scald, do not touch or place your bare hand near these two parts.
22. To avoid scald, watch out for the surging steam while uncovering the lid. Use a utensil with a long handle to check the doneness of food.
23. Never move the steamer while cooking is in progress.
24. Do not touch the drip tray until the appliance is unplugged and allowed to cool down to room temperature.
25. In order to avoid scald, remove the transparent lid carefully after cooking while keeping it away from your body. At the same time watch out for the condensate water.
26. When cooking is finished, the appliance should not be cleaned or washed immediately until the accessories cool down to room temperature.
27. Never immerse the appliance into water or wash it under running water.
28. To avoid any danger, do not connect the appliance to an external timer.
29. Do not use the appliance if the plug, the cord, the base or the product itself has been damaged.
30. Do not use the appliance for a prolonged period (within 1 hour) to avoid water overflow from the drip tray. If a longer period of usage is desired, make sure to remove the condensate water from the drip tray every hour. Ensure that no liquid leaks from the drip tray during operation.
31. Do not frequently connect and disconnect the water tank to avoid damage to the seal ring of the water tank, which can cause water leakage.
32. Residual water may be present in the drip tray. Cool down the drip tray, remove the water and wipe clean the drip tray before applying it again.
33. If there is residual water on the surface of the appliance, turn off power immediately and wipe it clean before resuming operation.
34. Do not dry heat the appliance for more than 10 minutes as it will reduce the steamer's service life.

Warning!

Do not touch the appliance when steaming is in progress since its surface temperature can be very high.

Product Structure

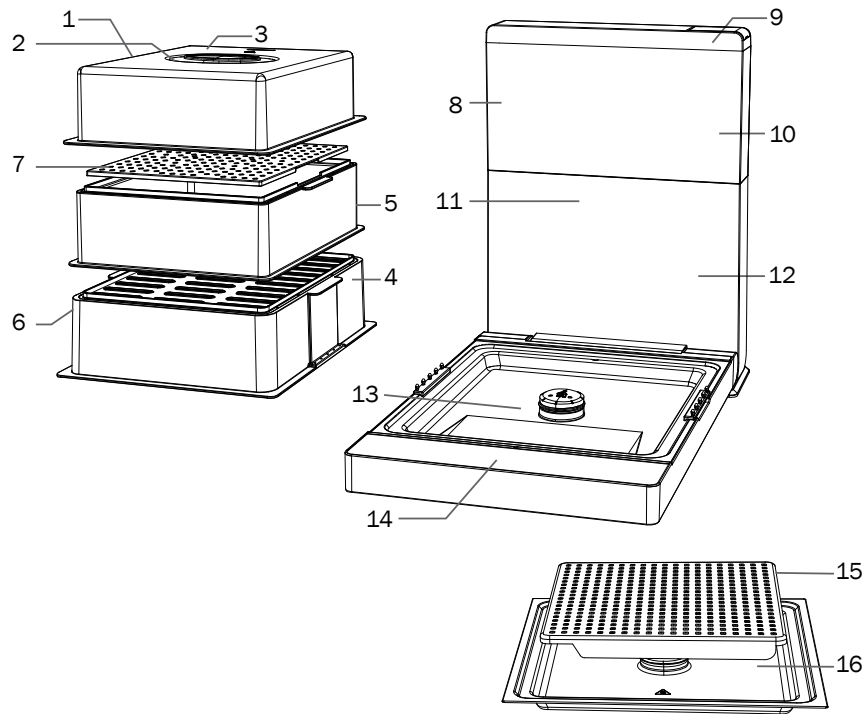

- | | |
|---------------------|---------------------------------|
| 1. Steam Lid | 10. Water Level Indicator |
| 2. Steamer Lid Grip | 11. LED Indicator |
| 3. Air Vent | 12. Main Body |
| 4. Steam Rack 1 | 13. Steam Generator |
| 5. Steam Rack 2 | 14. Control Panel |
| 6. Steam Basket 1 | 15. Stainless Steel Steam Plate |
| 7. Steam Basket 2 | 16. Stainless Steel Drip Tray |
| 8. Water Tank | |
| 9. Water Tank Lid | |

Operating Instructions

Prior to Usage

Remove the packaging. Clean the appliance before usage (refer to Care and Maintenance section). A slight scent of smoke or chemical substance may be detected during its initial application. The emission of odour is a normal phenomenon and it will disappear quickly.

Step 1:

Put the foldable steamer on a flat surface.

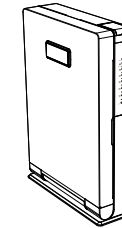

Watch the video clip



Step 2:

Unfold the steamer and install the drip tray and the steam plate onto the machine with the drip tray below the steam plate.

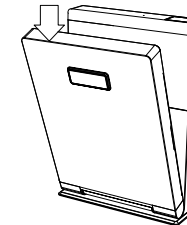

Step 3:

Fill required water into the water tank, and place ingredients onto the steam plate.

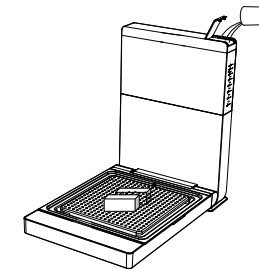

Step 4:



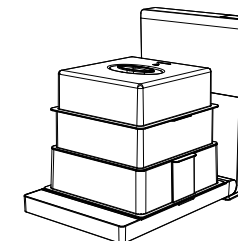





Cover the steamer with the lid. Plug the unit securely.



Operating Instructions

Step 5:

Select desired cooking time

1. Press “” button to select desired cooking function, and adjust cooking time by pressing the “” “” buttons;
2. Every press on these two buttons “+/-” 1 minute. Long pressing the buttons, the time will increase or decrease quickly. Start or pause the working process by pressing “” button. Cancel chosen function and select another desired one by pressing “”. Press it again to enter into cleaning function automatically;
3. Start preset function by pressing “” after selecting desired cooking function, and adjust the time by pressing the “” “” buttons. Every press on these two buttons “+/-” 1 minute. Long pressing the buttons, the time will increase or decrease quickly.



Step 6:

Take out the food after the cooking process is done. Allow the drip tray to cool down, remove it from the steamer and discard the condensate water.

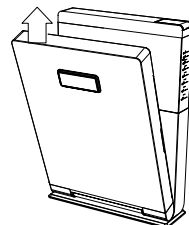
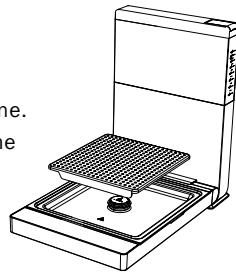

Step 7:

Wipe clean the steamer, fold it up and store it.

Operating Instructions

Continuous water drainage

Specially designed water draining function, enables steaming and prevents overflowing.

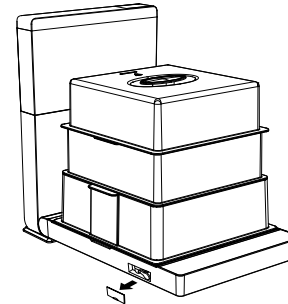

1. Open the lid on the side of the steamer

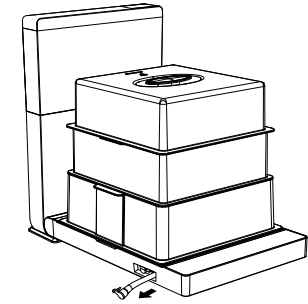

2. Pull out the drainage tube

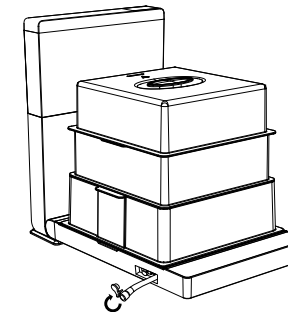

3. Open the cork on the tube

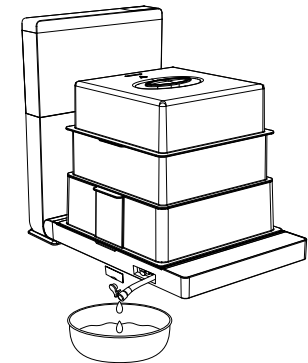

4. Use a container on the end of the tube to hold the water

Note: When using the water draining function, remove the stainless steel steam plate and drip tray, use the steam rack 1 to hold the food.

Care & Maintenance

1. Clean the appliance after every usage. Unplug the device and remove the condensate water in the drip tray before cleaning the steamer.
2. To avoid damaging the unit, do not use any cleaning agents such as soap, gasoline, thinner, alcohol, bleach, polishing powder, metallic brush, nylon brush and steel scourer to clean any part of the appliance.
3. Never immerse the appliance into water or wash it under running water.
4. Clean the steaming baskets, steamer lid and steam racks with water, and wipe it with a soft dry cloth. Only the metallic parts are dishwasher safe.
5. Make sure all the accessories are dirt-free and properly dried before putting them aside for storage.



Descaling the Foldable Steamer

Deposit of precipitate in the steam generator is a normal phenomenon after 2 - 3 months' application (There might be difference according to actual usage and water used). The amount of precipitate depends on the hardness of water. Regular descaling is essential to extend the appliance's service life. (Pure water is recommended).

The unit has auto alert function for cleaning. When the display shows “**CL**” icon, it means the unit should be cleaned before usage.

1. Pour 1500ml mixture of dedicated descaling agent and water into the water tank, (or 1500ml mixture of white vinegar and water at the volume ratio of 1: 4) (Do not use other chemicals);
2. Turn on the appliance. Start cleaning by pressing “**X**” button;
3. When the cleaning process finishes, the “**CL**” icon will disappear automatically from the display;
4. After cleaning, fill the water tank with pure water and steam for 10 minutes before cooking.

Trouble Shooting

If the following problems are encountered, follow the instructions below. If the problem persists, please contact our Customer Services and Repair Centre.

Note: For safety purpose, any unauthorised attempt to dismantle the product is prohibited.

Issues	Possible causes	Solutions
No steam is observed	<ol style="list-style-type: none"> 1. The appliance is not activated. 2. The unit is not plugged securely. 3. Power is not available. 4. Empty water tank. 	<ol style="list-style-type: none"> 1. Power up the appliance. 2. Insert the power plug again. 3. Connect to power. 4. Fill water into the water tank.
No steam is observed when it is started	<ul style="list-style-type: none"> • A protective measure to delay steam generation. 	<ul style="list-style-type: none"> • Wait about 25 seconds for steam to be generated.
The unit alarms and emits sounds of “Beep”	<ol style="list-style-type: none"> 1. No water in the water tank 2. With water in the tank, the air in the pipe is not discharged, which results in water level detect error. 	<ol style="list-style-type: none"> 1. Fill water into the water tank. 2. Remove the water tank, add a little water to discharge the air and then install it back to the unit.
The power indicator does not light up	<ul style="list-style-type: none"> • The appliance is not activated. 	<ul style="list-style-type: none"> • Power up the appliance.
The unit alarms and emits sounds of “Beep”, and the display shows “ CL ” at the same time	<ul style="list-style-type: none"> • The unit needs descaling. 	<ul style="list-style-type: none"> • Descale the steamer according to instructions described in "Care & Maintenance"
Water tank is leak	<ul style="list-style-type: none"> • The valve is stuck by items. 	<ul style="list-style-type: none"> • Remove the items.
Unable to fold the steamer	<ul style="list-style-type: none"> • High temperature environment will weaken the magnetic force. 	<ul style="list-style-type: none"> • Cool it down before putting it aside for storage.

Product Specifications

Model	JET-920
Voltage	220 - 240 V
Frequency	50 Hz
Power	1,500W
Dimensions (Folded)	(H) 430 mm (W) 480 mm (D) 300 mm
Net Weight	6.7 kg

Specifications are subject to change without prior notice.
If there is any inconsistency or ambiguity between the English version and the Chinese version, the Chinese version shall prevail.
Refer to www.germanpool.com for the most up-to-date version of the Operating Instructions.

Circuit Diagram

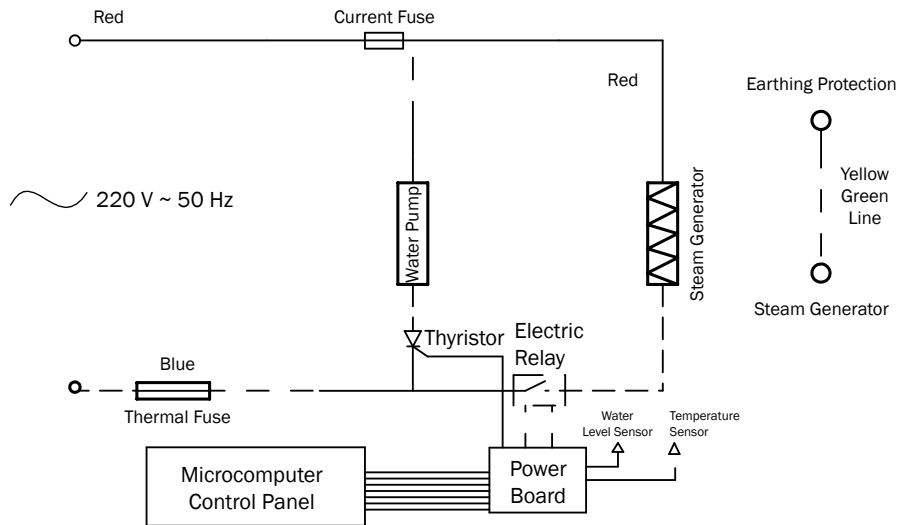

保用條款

此保用提供德國寶產品之機件在正常使用下壹年保用 (自購買日起計算)。

* 貴戶須在購機十天內，以下列其中一種方式向本公司登記資料，保用手續方正式生效：

- 1) 填妥本公司網頁內之保用登記表格
www.germanpool.com/warranty
- 2) 填妥保用登記卡，郵寄至本公司。



Warranty Terms & Conditions

Under normal operations, the product will guarantee a 1-year full warranty provided by German Pool (effective from the date of purchase).

* This warranty is not valid until customer registration information is received by our Service Centre within 10 days of purchase via one of the following means:

- 1) Visit our website and register online:
www.germanpool.com/warranty
- 2) Complete all the fields on the attached Warranty Card and mail it back to our Customer Service Centre.



另請填妥以下表格並與正本發票一併保存，以便維修時核對資料。用戶提供之所有資料必須正確無誤，否則免費保用將會無效。Please fill out the form below. This information and the original purchase invoice will be required for any repairs. Warranty will be invalidated if information provided is found to be inaccurate.

型號 Model No. : **JET-920**

機身號碼 Serial No. : _____ 發票號碼 Invoice No. : _____

購買商號 Purchased From : _____ 購買日期 Purchase Date : _____

1. 未能出示購買發票正本者，將不獲免費維修服務。
2. 用戶應依照說明書的指示操作。本保用並不包括：
 - 上門安裝、檢驗、維修或更換零件之人工以及一切運輸費用；
 - 因天然與人為意外造成的損壞 (包括運輸及其他)；
 - 電源接合不當、不依說明書而錯誤或疏忽使用本機所引致之損壞。
3. 於下列情況下，用戶之保用資格將被取消：
 - 購買發票有任何非認可之刪改；
 - 產品被用作商業或工業用途；
 - 產品經非認可之技術人員改裝或加裝任何配件；
 - 機身編號被擅自塗改、破壞或刪除。
4. 總代理有權選擇維修或更換配件或其損壞部份。
5. 產品一經被轉讓，其保用即被視作無效。

1. Customer who fails to present original purchase invoice will not be eligible for free warranty service.
2. Customer should always follow the operating instructions. This warranty does not apply to:
 - labour costs for on-site installation, check-up, repair, replacement of parts and other transportation costs;
 - damages caused by accidents of any kind (including material transfer and others);
 - operating failures resulting from applying incorrect voltage, improper usage, and unauthorized installations or repairs.
3. This warranty is invalid if:
 - the purchase invoice is modified by an unauthorized party;
 - the product is used for any commercial or industrial purposes;
 - the product is repaired or modified by unauthorized personnel, or unauthorized parts are installed;
 - the serial number is modified, damaged or removed from the product.
4. German Pool will, at its discretion, repair or replace any defective part.
5. This warranty will be void if there is any transfer of ownership from the original purchaser.

客戶服務及維修中心

中國香港

九龍灣啟興道1-3號

九龍貨倉10樓

電話：+852 2333 6249

傳真：+852 2356 9798

電郵：repairs@germanpool.com

中國澳門

澳門俾利喇街145號

寶豐工業大廈3樓

電話：+853 2875 2699

傳真：+853 2875 2661

Customer Service & Repair Centre

Hong Kong, China

10/F, Kowloon Godown

1-3 Kai Hing Road, Kowloon Bay,

Kowloon, Hong Kong

Tel : +852 2333 6249

Fax : +852 2356 9798

Email : repairs@germanpool.com

Macau, China

3/F, Edificio Industrial Pou Fung,

145 Rua de Francisco Xavier Pereira,

Macau

Tel : +853 2875 2699

Fax : +853 2875 2661



德國寶(香港)有限公司 German Pool (Hong Kong) Limited

中國香港
Hong Kong, China

香港九龍土瓜灣馬頭角道116號
新寶工商中心2期113號室
Room 113, Newport Centre Phase II, 116 Ma Tau
Kok Road, Tokwawan, Kowloon, Hong Kong.
電話 Tel: +852 2773 2888
傳真 Fax: +852 2765 8215

中國內地
Mainland China

廣東省佛山市順德區
大良五沙工業區新翔路8號
8th, Xinxiang Road, Wusha Industrial Park,
Daliang, Shunde, Foshan, Guangdong, China
電話 Tel: +86 757 2388 1896
傳真 Fax: +86 757 2980 8318

中國澳門
Macau, China

澳門俾利喇街145號
寶豐工業大廈3樓
3/F, Edificio Industrial Pou Fung,
145 Rua de Francisco Xavier Pereira, Macau
電話 Tel: +853 2875 2699
傳真 Fax: +853 2875 2661



香港名牌十年成就獎
HONG KONG TOP BRAND TEN YEAR
ACHIEVEMENT AWARD



香港(S MARK)
安全認證



中國品牌/家電行業
十大影響力品牌



CEO非凡品牌大賞



香港優質商號



香港工商業獎



2007
最具潛質
創建品牌企業獎



香港中小企業
最佳拍檔大獎



香港消費者推銷品牌



香港(O榜)
優質服務證書

© 版權所有。未獲德國寶授權，不得翻印、複製或使用本說明書作任何商業用途。違者必究。
© All rights reserved. Copying, reproducing or using the contents of this manual is not allowed without prior authorization from German Pool, violators will be prosecuted.

www.germanpool.com